

OPTIMIZATION OF DESIGN SEISMIC COEFFICIENT BASED ON TOTAL EXPECTED COST FOR GRAVITY TYPE QUAY WALLS

Koji ICHII¹

¹Member of JSCE, M.Eng., Researcher, Port and Airport Research Institute
(Nagase 3-1-1, Yokosuka 239-0826, Japan)
E-mail: ichii@pari.go.jp

An optimization procedure for the design seismic coefficient for gravity type quay walls is discussed based on the risk management concept. First, seismic risk evaluation for 280 ports in Japan is conducted to obtain the optimum design seismic coefficient. Second, the variation of the optimum seismic coefficient for the important quay wall or the quay wall with longer service life than usual is examined. Finally, the relationship between peak ground acceleration given by seismic hazard analysis and the optimum design seismic coefficient is examined. The results indicate that the current design seismic coefficient is regarded as reasonable since it is close to or conservative of the optimum design seismic coefficient.

Key Words: quay wall, seismic coefficient, seismic risk, risk management, seismic performance

1. INTRODUCTION

In current design practice for gravity type quay walls, the pseudo-static approach with a design seismic coefficient is utilized.¹⁾ The seismic coefficient is defined as the seismic load divided by the weight, based on the assumption that the seismic load is proportional to the structure's weight. The seismic load is assumed to act as a static load in the pseudo-static method, though the actual seismic load is a dynamic load induced by input ground motion. Therefore, the relation between seismic coefficient and the level of input ground motion required the damage to quay walls is examined.^{2), 3)} Furthermore, a simplified damage evaluation technique using the seismic coefficient is developed⁴⁾, and the effect of design seismic coefficient improvement on seismic risk reduction is examined also.⁵⁾

Since all the structures must be stable against level-1 earthquake motions whose return periods are about 75 years in current design practice¹⁾, the design seismic coefficient represents the ground motion level for the level-1 earthquake.³⁾ Here, return period is defined only in a probabilistic way and it does not imply that the ground motion level of the level-1 earthquake occurs every 75 years. For example, the probability of a structure with a lifetime of 50 years to encounter a ground motion level with

a return period of 75 years or more is approximately 50%.

However, probabilistic information such as the probability of encounters for a certain level of ground motion is quite vague for the designer. It is simple to say, why 50% for 50 years and why not 25% for 100 years or something else? Is the optimum procedure in the design of gravity type quay walls to give the design seismic coefficient that corresponds to the ground motion whose occurrence probability is only 50%, even if the quay wall will be used for 50 years? In addition, how much should the designer increase the design seismic coefficient if the quay wall is important? To answer these questions, the risk management procedure is useful. For example, once the risk is defined in terms of cost such as annual expected loss (AEL)⁶⁾, the cost/benefit balance of seismic retrofit (seismic performance improvement) can be considered, and hence, its optimization is possible.^{7), 8)} Since a risk assessment procedure for gravity type quay walls has already been proposed by the author⁵⁾, a risk management procedure is applied to optimize the design seismic coefficient for gravity type quay walls in this paper.

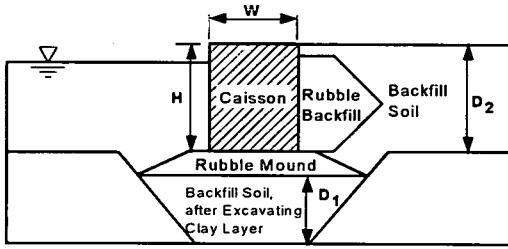

Fig. 1 Cross section and parameters of gravity type quay wall

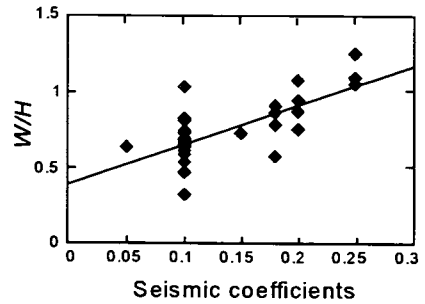

Fig. 2 Correlation between the width to height ratio (W/H) and seismic coefficient of a gravity type quay wall⁹⁾

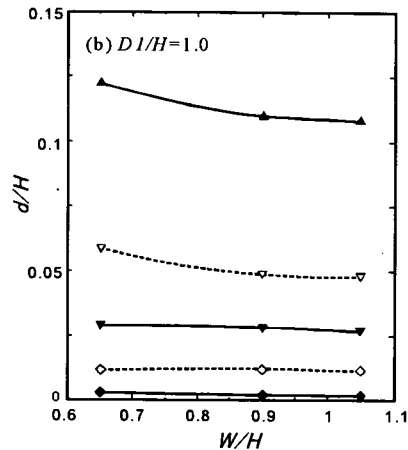
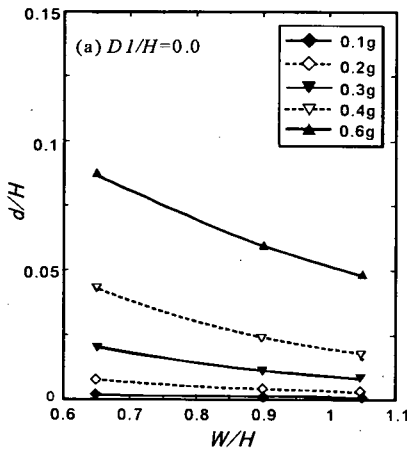

Fig. 3 Effects of the width to height ratio W/H (for equivalent SPT N-value of 15)⁹⁾

2. SEISMIC RISK EVALUATION CONSIDERING REGIONAL SEISMIC HAZARD

Gravity type quay walls are made of concrete caissons or other retaining structures placed on a foundation, sustaining earth pressures from backfill soil behind the wall. The factors governing seismic performance of a gravity type quay wall include wall dimensions, the thickness of soil deposit below the wall, and the liquefaction resistances of subsoil below and behind the wall, as well as the levels of seismic shaking at the basement. A schematic figure of a gravity type quay wall is shown in Fig. 1. Major cross sectional dimensions are specified by the width (W) and the height (H) of gravity wall, and thickness of subsoil below the caisson ($D1$) and behind the caisson ($D2$). The width to height ratio (aspect ratio: W/H) of a gravity type quay wall is one of the most important parameters since it has been correlated with the seismic coefficient as shown in Fig. 2 using Japanese case histories.

Randomly selected 40 cases are used for this figure since there are large number of gravity type quay walls. The reason why the data in Fig. 2 are scattered is W/H is dependent on not only seismic coefficient but also geotechnical condition such as internal friction angle of backfill. Since there are large number of cases with seismic coefficient of 0.1, W/H for the seismic coefficient of 0.1 are scattered in wide range. However, since the average value of W/H is clearly dependent on seismic coefficient, W/H was chosen as the index parameter of seismic coefficient in this research.

Using these parameters, a parametric study with an effective stress based finite element method is conducted in order to prepare simple seismic performance evaluation charts.⁹⁾ A finite element code called FLIP¹⁰⁾ with multi-spring model and the ground motion observed at Kobe Port Island site during 1995 Hyogoken-nanbu earthquake was used in the parametric study. Fig. 3 shows an example of the charts with an assumption that $D2=H$ for simplicity, where d/H is the normalized seaward dis-

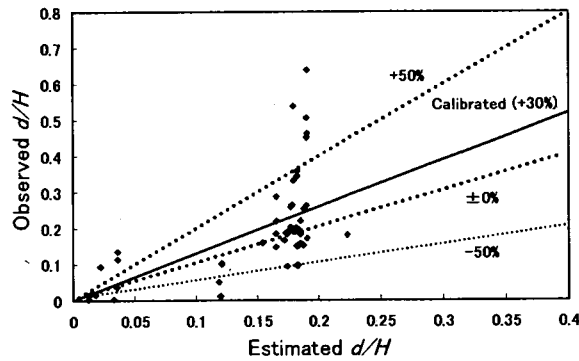

Fig. 4 Applicability verification results of the seismic performance evaluation charts⁵⁾

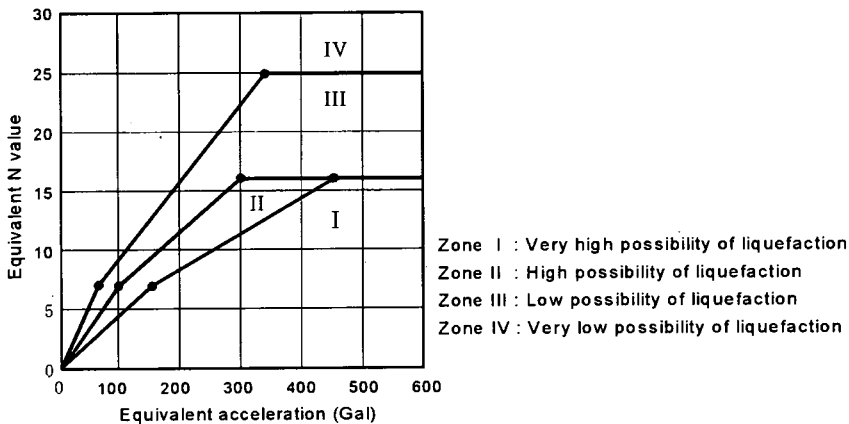

Fig. 5 Classification of soil layer for liquefaction prediction based on equivalent acceleration and equivalent N values¹⁾

placement at the top of the wall (seaward displacement divided by the wall height). It indicates that a larger W/H gives a smaller damage of the quay wall if $D1/H=0.0$ (no sand deposit layer below the caisson) but not in the case if $D1/H=1.0$ (deep sand deposit layer below the caisson). It means that an increase of seismic coefficient is effective for the reduction of seismic damage if there is no sand deposit layer below the caisson, but it is not effective if there is deep sand deposit layer since the deformation of the sand deposit layer is dominant in this case.

Based on the aspect ratio (W/H) and peak acceleration level at the basement, a rough estimate of the deformation level of a quay wall can be obtained with this figure. The applicability of these charts was verified with 55 case histories in Kobe Port (1995 Hyogoken-nanbu earthquake) and Kushiro Port (1993 Kushiro-oki earthquake) as shown in Fig. 4⁵⁾.

It should be noted here that the equivalent SPT N values for the sand deposit below and behind caisson is assumed to be 15 in Fig. 3. The equivalent

SPT N value is the corrected SPT N value for an effective vertical stress of 65 kPa in terms of equivalent relative density and is commonly used for liquefaction prediction in Japanese port areas.¹⁾ As shown in Fig. 5, the equivalent SPT N value of 15 is close to the threshold of the high possibility of liquefaction range regardless equivalent acceleration levels. It means that the charts in Fig. 3 are for the case with no liquefaction occurrence and agrees with the current design requirement, since liquefaction countermeasures should be installed under the current design code if liquefaction occurrence were predicted.

Since the optimization of the seismic coefficient for use in pseudo-static approach is the focus of this paper, the assumption of pseudo-static approach is utilized, i.e. no liquefaction and/or deformation of sand deposit below the caisson is considered. Therefore, Fig. 3 (a) is used in the following discussion.

Based on the seismic performance evaluation charts, a risk assessment procedure with Monte Carlo simulation using the variance of the actual

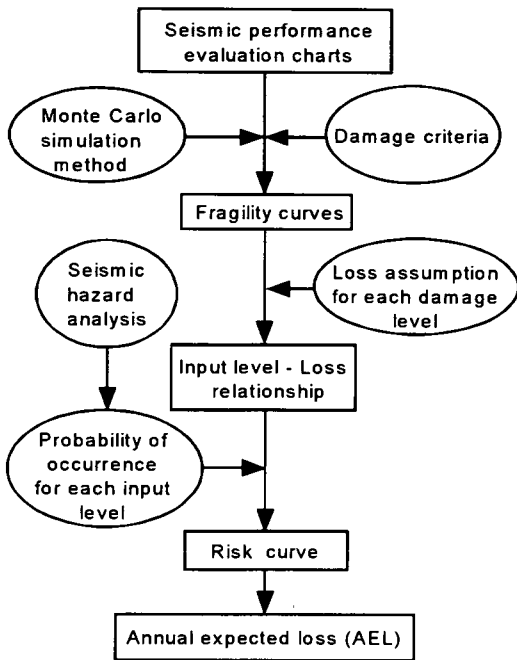

Fig. 6 Flow chart of risk assessment procedure

displacement and the estimated displacement by the charts as the parameter of randomness is proposed by the author⁵. The flow chart of the risk assessment procedure is shown in Fig. 6. As a result of the risk assessment procedure, annual expected loss is obtained, which is defined as the product of probability and loss as follows⁶,

$$AEL = \int_0^{\infty} P_h(x) \sum_j \{ P_f(c_j|x) \cdot c_j \} dx \quad (1)$$

where, $P_h(x)$ is the hazard (annual probability of occurrences for strong ground motion level of x); $P_f(c_j|x) \cdot c_j$ is the fragility, which is defined as the product of $P_f(c_j|x)$ (the probability of occurrence of j -th damage level for strong ground motion level of x) and c_j (the magnitude of loss for the j -th damage level).

The seismic hazard $P_h(x)$ can be calculated as the results of seismic hazard analysis. For example, Nozu et al. conducted a seismic hazard analysis for Japanese coastal area with historical earthquake data during 1885 to 1995³. The probability of damage occurrence $P_f(c_j|x)$ can be given as fragility curves. For example, the author applied Monte Carlo simulation to obtain fragility curves for gravity type quay walls under various conditions⁵. The

Table 1 Damage criteria and its loss⁵⁾

| Damage level | Normalized seaward displacement (d/H) | Loss (1000yen/m) |
|--------------|---|------------------|
| Degree I | 1.5~5% | 500 |
| Degree II | 5~10% | 1,000 |
| Degree III | 10~15% | 5,000 |
| Degree IV | Larger than 15% | 15,000 |

magnitude of loss c_j is an important parameter, but difficult to be defined. For example, Table 1 shows a damage level criteria based on normalized seaward displacement and its loss per unit length of quay wall based on restoration cost⁵. Although this criteria do not consider the indirect loss such as the economic impact on society, this damage criteria and loss estimation was used in this paper since it gives conservative loss estimation. Restoration cost might be dependent on the characteristic of quay wall. For example, since the price of the structure designed with large seismic coefficient is higher than that with small seismic coefficient, cost of the damage might be higher even if the damage is the same. However, this effect is not considered in this research since restoration cost is dependent on many other factors such as size of quay wall, restoration method, etc., and the restoration cost data scattered too much to consider these differences⁵.

Once AEL to the quay wall is estimated, risk reduction through the improvement of initial construction can be regarded as the benefit. Hence, the designer of a quay wall can discuss the optimum design seismic coefficient as an optimization of the cost/benefit balance of the initial construction cost.

3. BACKGROUND OF REGIONAL DESIGN SEISMIC COEFFICIENT IN JAPAN

In current design practice, design seismic coefficient should be determined with the following equation.

$$\begin{aligned} \text{Seismic coefficient} &= \text{Regional seismic coefficient} \\ &\quad \times \text{Factor for subsoil condition} \\ &\quad \times \text{Importance factor} \end{aligned} \quad (2)$$

Regional seismic coefficient is given in five categories (Region A, 0.15, to Region E, 0.08), as shown in Fig. 7. It has been determined from the

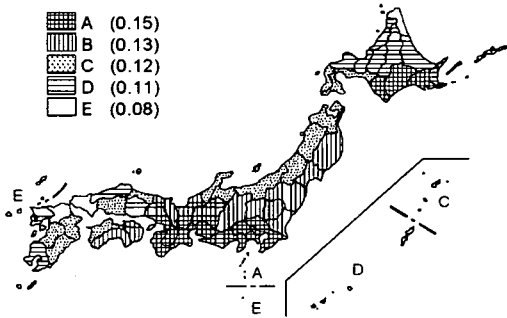

Fig. 7 Regional design seismic coefficient definition for Japanese ports¹⁾

Table 2 Regional seismic coefficient and PGA¹⁾

| Area | Regional seismic coefficient | Peak ground acceleration at baserock with return period of 75 years (Gal) (SMAC equivalent) |
|------|------------------------------|---|
| A | 0.15 | 350 |
| B | 0.13 | 250 |
| C | 0.12 | 200 |
| D | 0.11 | 150 |
| E | 0.08 | 100 |

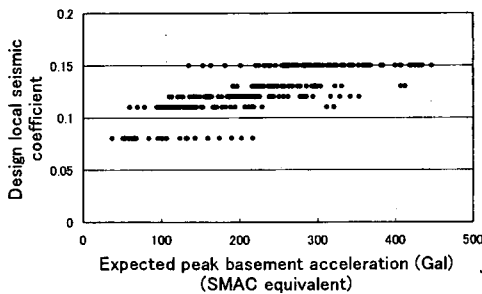

Fig. 8 Regional design seismic coefficient distribution

distribution of peak ground acceleration with a return period of 75 years¹⁾, based on an averaged relation between seismic coefficient and peak ground acceleration at baserock as shown in Table 2. To obtain the distribution of peak ground acceleration with a return period of 75 years, a seismic hazard analysis for the Japanese coastal area was conducted based on historical earthquakes from 1885 to 1995³⁾. Since the seismic hazard analysis was conducted for each ports, an averaging procedure was conducted to obtain a single value of seismic hazard for each region.

It should be noted here that the peak ground acceleration in Table 2 is expressed in terms of SMAC equivalent acceleration. The SMAC equivalent acceleration is the acceleration filtered by the SMAC equivalent filter in order to get the maximum accel-

Table 3 Factor for subsoil condition¹⁾

| Classification | 1st kind | 2nd kind | 3rd kind |
|----------------|----------|----------|----------|
| Factor | 0.8 | 1.0 | 1.2 |

Table 4 Classification of subsoil¹⁾

| Thickness of Quaternary deposit | Gravel | Sand or clay | Soft ground |
|---------------------------------|--------|--------------|-------------|
| less than 5m | 1st | 1st | 2nd |
| 5-25m | 1st | 2nd | 3rd |
| more than 25m | 2nd | 3rd | 3rd |

Table 5 Importance factor¹⁾

| Category | Special | A | B | C |
|----------|---------|-----|-----|-----|
| Factor | 1.5 | 1.2 | 1.0 | 0.8 |

eration value which corresponds to the virtual acceleration, which might be observed if the SMAC-B2 type accelerograph was installed at the site¹⁾. Since the SMAC-B2 type accelerograph is insensitive to the high frequency component, the SMAC equivalent acceleration is less than the actual observed value. The relationship between regional seismic coefficient and peak ground acceleration (SMAC equivalent) with a return period of 75 years is shown in Fig. 8. The data scattered since averaging procedure was conducted in defining the regional seismic coefficient as shown in Fig. 7, and the local seismic hazard for each port are not identical with regional seismic hazard used for the definition of regional design seismic coefficient.

The factor for subsoil condition is given in three categories as shown in Table 3, and these categories are determined by the thickness of the Quaternary deposit, as shown in Table 4. The importance factor is given in four categories as shown in Table 5, based on the possibility of human life loss, magnitude of possible economic impact, difficulty of restoration, etc.

For 280 ports in Japan, where the results of seismic hazard analysis were given³⁾, the risks of a gravity type quay wall defined as annual expected loss, AEL in equation (1), are calculated as shown in Fig. 9. The results of seismic hazard analysis by Nozu et al.³⁾ and the fragility curves by the author⁵⁾ were applied to calculate these risks. The assumptions for Fig. 9 are that no sand deposit exists below the caisson ($D1/H=0.0$); the equivalent SPT N value for backfill is 15; and the aspect ratio of caisson (W/H) corresponds to the regional seismic coefficient. The

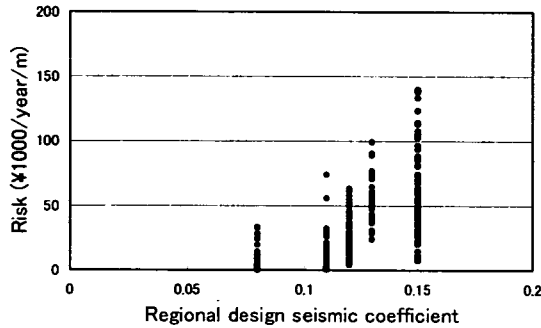

Fig. 9 Relationship between regional seismic coefficient and estimated seismic risk

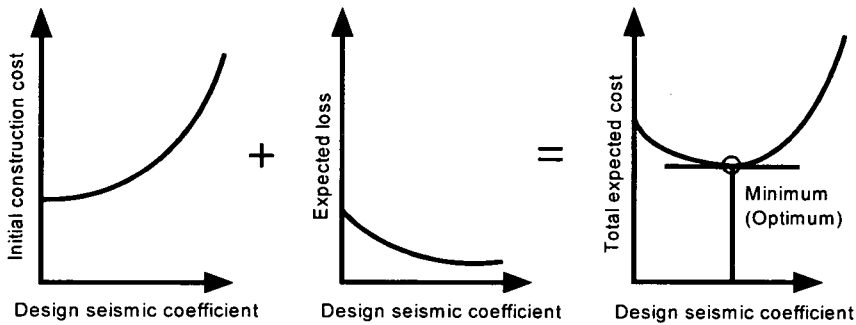

Fig. 10 Principle to minimize the total cost^{(7), (8)}

reason why the calculated seismic risks are scattered is that seismic risk is dependent on the balance of seismic hazard level and seismic resistant design level, however, the regional seismic coefficients, which defines the seismic resistant design level, are dependent on not only seismic hazard level but also other factors such as averaging effect. Since Fig. 9 indicates that a quay wall with larger regional seismic coefficient has a larger risk, it can be concluded that a quay wall in seismically active area have larger risk than others even though it is designed with a larger seismic coefficient.

It should be noted here that the damage of a quay wall is dependent on not only peak value of ground acceleration but also other factors such as dominant frequency. However, since peak ground acceleration was used to define design seismic coefficient in current design standard of port structures, the author used peak ground acceleration as the index of input motion level. Since Fig. 3 is the basis of the risk analysis in this paper, peak value of the acceleration corresponds to the input motion for Fig. 3, which was the recorded motion in Kobe Port Island site. Some correction factors can be introduced to consider other factors such as dominant frequency, however, it is beyond the scope of this paper.

4. OPTIMIZATION OF DESIGN SEISMIC COEFFICIENT

Based on the risk assessment procedure, the optimum design seismic coefficient can be defined as shown in Fig. 10^{(7), (8)}. The optimum design seismic coefficient minimizes the total cost, which is defined as the sum of initial construction cost and total expected loss for the duration of the facility service life.

The initial construction cost for a gravity type quay wall increases non-linearly with an increase in the design seismic coefficient. This is because the effect of the inertia force of a caisson wall becomes major under large input level. The seismic earth pressure also increases significantly for a large seismic coefficient. Thus, a caisson wall is very wide for large seismic coefficient as shown in Fig. 11, and initial construction cost increases significantly as shown in Fig. 12⁽¹¹⁾. These construction cost were estimated for the quay walls shown in Fig. 11 based on the standard construction cost estimation procedure. The caisson wall with $Kh=0.0$, which corresponds to the quay wall without earthquake resistant design, is a virtual one and not exist in Japanese ports. The linear correlation applied to the relation between the aspect ratio (W/H) and

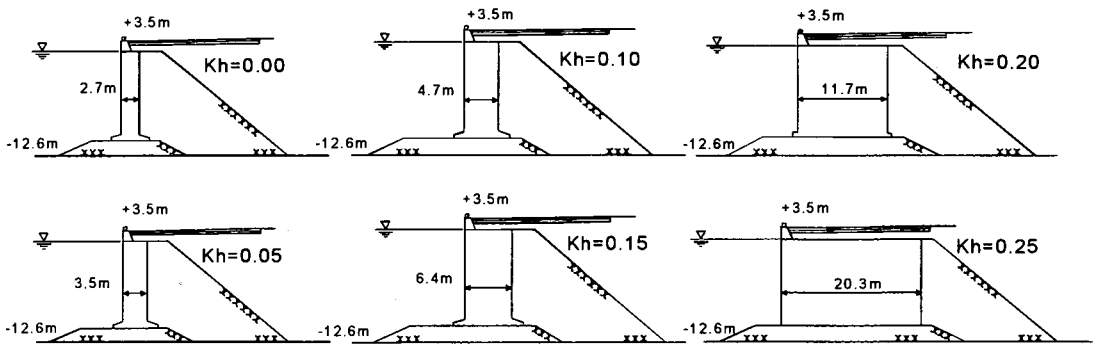

Fig. 11 Examples of gravity type quay wall design for seismic coefficient of 0.0 to 0.25¹¹⁾

seismic coefficient shown in Fig. 2 is not correct, and a non-linear correlation should be applied. However, due to the scattered data in Fig. 2, the linear correlation will still be used for simplicity. It should be noted here that the initial construction costs in Fig. 12 were corrected with the construction cost index for the price in the year of 1995, when most of the restoration cost data for the risk evaluation was obtained.⁵⁾ Although the construction cost will vary regionally, Fig. 12 is used for the initial construction cost in the following risk management process.

If the duration of the facility service life is assumed to be 50 years, which corresponds to the probability of level-1 earthquake occurrence of approximately 50%, the total expected loss can be given as the 50 times the annual expected loss. And annual expected loss is estimated by equation (1).

Although there could be many ways to evaluate cost/benefit balance, initial construction cost shown in Fig.12 and AEL by equation (1) might be appropriate for gravity type quay wall case since other cost such as maintenance cost can be neglected. Thus the optimum design seismic coefficient can be obtained. For example, Fig. 13 shows optimum design seismic coefficient for Kobe Port and Sakai Port. Since linear interpolation is applied, the optimum value is obtained only in discrete values. In Kobe Port, the optimum design seismic coefficient is given as 0.15 to minimize the total cost. However, it is obvious from the figure that the real optimum value is somewhere between 0.1 and 0.15. In Sakai Port, the optimum design seismic coefficient is 0.0, which implies that it is not necessary to do seismic design in this port. However, these results are based on many assumptions and simplifications, and the author believes that we should be conservative in our decision-making in extreme situations such as the Sakai Port case.

It should be noted here that the calculated total expected loss is dependent on the damage level cri-

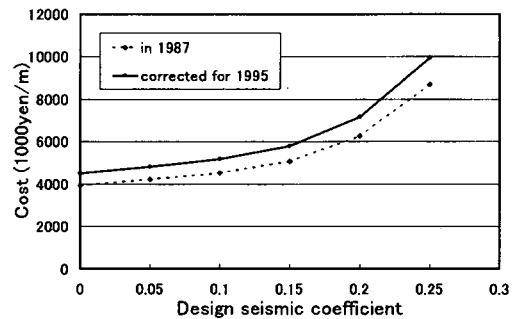
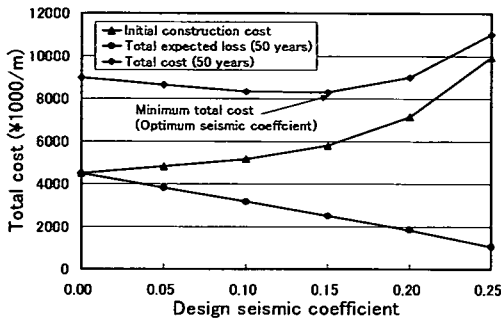

Fig. 12 Construction cost increase due to seismic coefficient increase

teria and loss definition shown in Table 1. Thus, the robustness of the optimum seismic coefficient is dependent on the robustness of the damage level criteria and its loss definition. Since the effect of the W/H increase, which related with design seismic coefficient, is almost linear as shown in Fig. 3, total expected loss decrease almost linearly with increase of design seismic coefficient. Since the initial construction cost increase nonlinearly in high design seismic coefficient region, it implies that the robustness of the optimum seismic coefficient is bad especially in small seismic coefficient region.

For 280 ports in Japan, optimum design seismic coefficients are summarized in Table 6. For the high seismic activity region, where regional seismic coefficient is large, the average of optimum design seismic coefficient agrees the regional seismic coefficient in general. The reason why the average for area A is less than area B is that some ports with low seismic hazard are classified as area A by the averaging procedure as shown in Fig. 7. For the low seismic activity region, the average of the optimum design seismic coefficient is fairly smaller than the regional seismic coefficient. However, from a conservative point of view, it is reasonable to assume a relatively larger design seismic coefficient in a low



(a) Kobe Port

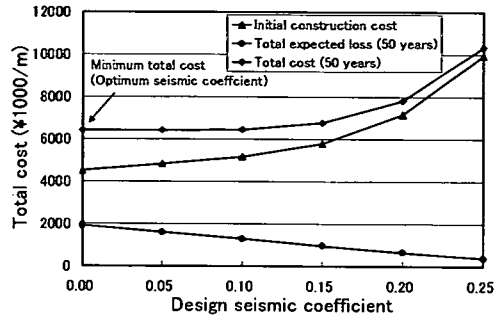

(b) Sakai Port

Fig. 13 Examples of seismic coefficient optimization

Table 6 Optimum seismic coefficient distributions for 50 years of service life

| Area | Regional seismic coefficient | Optimum seismic coefficient | | | | | | Average | Total |
|------|------------------------------|-----------------------------|------|-----|------|-----|------|---------|-------|
| | | 0 | 0.05 | 0.1 | 0.15 | 0.2 | 0.25 | | |
| A | 0.15 | 4 | 0 | 26 | 26 | 22 | 0 | 0.13974 | 78 |
| B | 0.13 | 0 | 0 | 13 | 12 | 9 | 0 | 0.14412 | 34 |
| C | 0.12 | 37 | 1 | 33 | 9 | 1 | 0 | 0.06049 | 81 |
| D | 0.11 | 52 | 1 | 5 | 1 | 0 | 0 | 0.01186 | 59 |
| E | 0.08 | 27 | 0 | 1 | 0 | 0 | 0 | 0.00357 | 28 |

seismic activity region.

It should be noted here that since no sand deposit layer below the caisson is assumed in this case study, the factor of subsoil condition of 0.8 (1st kind subsoil) has to be considered for the design seismic coefficient. In this case, the regional seismic coefficient is smaller than the optimum coefficient in the high seismic activity region, and it is larger than optimum in the low seismic region. Thus, if the factor of subsoil condition is appropriate, some modification is necessary to optimize the regional seismic coefficient. However, the effect of design seismic coefficient improvement (increase of the aspect ratio: W/H) for the quay wall with a subsoil layer below caisson was not confirmed by case histories. Furthermore, numerical results show that this effect is minor as shown in Fig. 3 (b). Thus, the background of the factor of subsoil for seismic coefficient is not clear, and the factor of subsoil is ignored in the following discussion.

Geotechnical condition for the optimization of design seismic coefficient in this paper is identical with that of Fig. 3 (a), which corresponds the equivalent SPT N value of 15 for backfill and no sandy deposit below the caisson. It is close to the condition assumed in the current design practice. For other geotechnical condition, the value of optimum design seismic coefficient might be different, however, it is beyond the scope of this paper.

As a conclusion, the current regional seismic coefficient definition is reasonable and close to the optimum seismic coefficient. In other words, for the question 'why 50% for 50 years?' in the first chapter, the answer is 'because it will give an optimum seismic design for the facility, if its service life is 50 years'.

5. VARIATION OF THE OPTIMUM SEISMIC COEFFICIENT

To answer another question in first chapter, 'how much should the designer increase the design seismic coefficient if the quay wall is important', a parametric study is conducted. The increase of importance can be represented by an increase in estimated loss. For example, if the economic loss for each damage level is doubled, the annual expected loss is also doubled. Furthermore, the case of twice the total expected loss is identical to the case of twice the duration of service life. Therefore, the variation of optimum seismic coefficient for the service life of 100 years and 200 years is examined in this chapter.

Tables 7 and 8 show the results of optimum seismic coefficient for the quay wall with service life of 100 years and 200 years, respectively. Since the initial construction cost data is available only up to a seismic design coefficient of 0.25 and it will in-

Table 7 Optimum seismic coefficient distributions for 100 years of service life

| Area | Regional seismic coefficient | Optimum seismic coefficient | | | | | | Average | Total |
|------|------------------------------|-----------------------------|------|-----|------|-----|------|---------|-------|
| | | 0 | 0.05 | 0.1 | 0.15 | 0.2 | 0.25 | | |
| A | 0.15 | 1 | 0 | 3 | 29 | 33 | 12 | 0.18269 | 78 |
| B | 0.13 | 0 | 0 | 0 | 14 | 20 | 0 | 0.17941 | 34 |
| C | 0.12 | 7 | 0 | 23 | 46 | 5 | 0 | 0.12593 | 81 |
| D | 0.11 | 35 | 4 | 11 | 8 | 1 | 0 | 0.04576 | 59 |
| E | 0.08 | 22 | 1 | 4 | 1 | 0 | 0 | 0.02143 | 28 |

Table 8 Optimum seismic coefficient distributions for 200 years of service life

| Area | Regional seismic coefficient | Optimum seismic coefficient | | | | | | Average | Total |
|------|------------------------------|-----------------------------|------|-----|------|-----|------|---------|-------|
| | | 0 | 0.05 | 0.1 | 0.15 | 0.2 | 0.25 | | |
| A | 0.15 | 0 | 0 | 0 | 4 | 33 | 41 | 0.22372 | 78 |
| B | 0.13 | 0 | 0 | 0 | 0 | 23 | 11 | 0.21618 | 34 |
| C | 0.12 | 0 | 0 | 7 | 31 | 39 | 4 | 0.17469 | 81 |
| D | 0.11 | 15 | 1 | 17 | 19 | 5 | 2 | 0.10339 | 59 |
| E | 0.08 | 17 | 1 | 4 | 5 | 1 | 0 | 0.05000 | 28 |

crease significantly for over 0.25, the maximum seismic coefficient is given as 0.25 even if the optimum seismic coefficient will be over 0.25. The average values for each seismic region are shown in Fig. 14.

Since the robustness of the optimum seismic coefficient is less in the small regional seismic coefficient, the values for the regional seismic coefficient of 0.13 and 0.15 are focused. It indicates that the optimum design seismic coefficients increase approximately 20% and 50% for the service life of 100 years and 200 years, respectively. Thus, the importance factor of 1.2 (A class) and 1.5 (Special class) correspond to approximately twice and four times of service life, respectively.

Although it is difficult to evaluate the importance of a quay wall, the author thinks that twice of importance might be corresponds to twice of loss if it was damaged. And twice of expected loss corresponds to twice of service life if expected loss per year is constant. Thus, the importance factor of 1.2 and 1.5, which corresponds twice and four times of service life, corresponds to twice and four times of importance, respectively.

To discuss the relationships between seismic hazard and optimum seismic coefficient, the optimum seismic coefficient for service life of 50, 100, and 200 years and the peak ground acceleration at the baserock for the earthquake whose probability of occurrence during the facility service life is approximately 50% are examined as shown in Fig. 15. Though the results are scattered, the general relationship is the same. Therefore, regardless the length

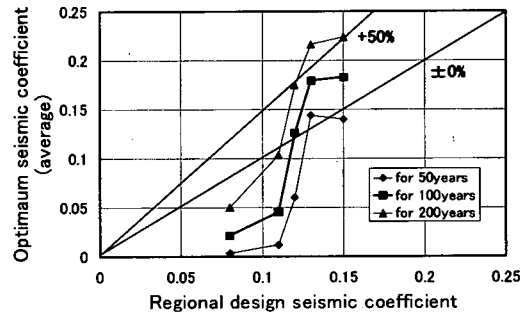

Fig. 14 Average of design optimum seismic coefficient

of the facility service life, it is reasonable to assume the earthquake whose probability of occurrence is 50% as the level-1 earthquake. It should be noted here again that the seismic coefficient in current design is determined by SMAC-B2 equivalent acceleration, and the acceleration in Fig. 15 is also expressed in SMAC-B2 acceleration.

For the relationship between SMAC-B2 equivalent peak ground acceleration and seismic coefficient, the following equation is proposed.²⁾

$$\begin{aligned}
 K_h &= A_{SMAC} / g \quad (A_{SMAC} \leq 200 \text{ Gal}) \\
 K_h &= \frac{1}{3} \left(\frac{A_{SMAC}}{g} \right)^{\frac{1}{3}} \quad (A_{SMAC} > 200 \text{ Gal})
 \end{aligned}
 \tag{3}$$

Where, K_h is the upper limit of equivalent seismic coefficient acting on the quay wall for the SMAC-B2 equivalent peak ground acceleration

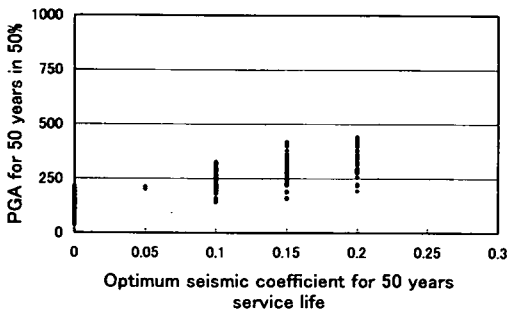

(a) 50% occurrence probability for 50 years

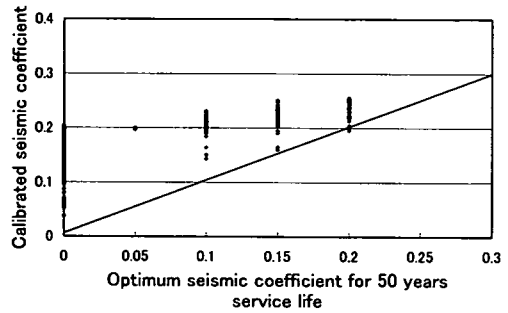

(a) 50% occurrence probability for 50 years

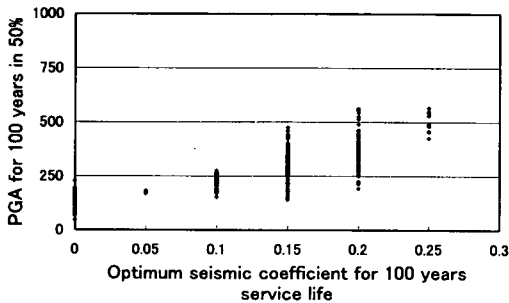

(b) 50% occurrence probability for 100 years

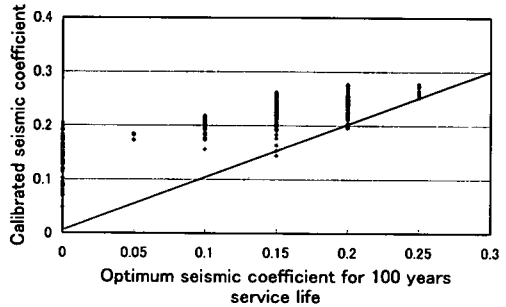

(b) 50% occurrence probability for 100 years

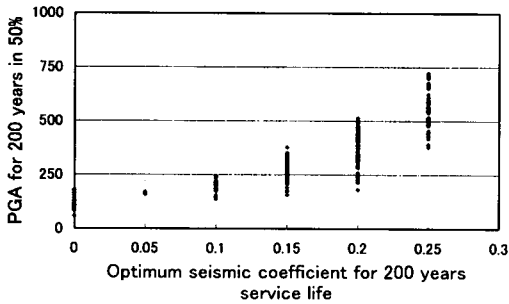

(c) 50% occurrence probability for 200 years

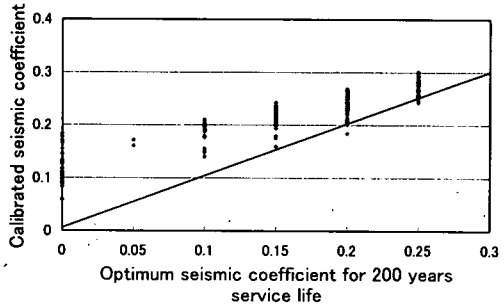

(c) 50% occurrence probability for 200 years

Fig. 15 Optimum design seismic coefficient and expected PGA

Fig. 16 Optimum design seismic coefficient and calibrated seismic coefficient

of A_{SMAC} (Gal). Although this relation is for the peak ground acceleration at the ground surface and gives only a conservative relation, it is applied as a rough evaluation for the cases shown in Fig. 15. The results are summarized in Fig. 16, and it shows that equation (3) works well to give a conservative definition of design seismic coefficient regardless of the duration of facility service life. Thus, the current design seismic coefficient definition is based on a background to minimize the total cost and reasonable, since it is close to or conservative of the optimum design seismic coefficient.

6. CONCLUSIONS

An optimization procedure for the design seismic coefficient and background of current design seismic coefficient for gravity type quay walls were discussed based on the risk management concept. Although it has been a controversial theme to define an optimum design seismic design for public structures, the author believes the proposed optimization procedure works well, and in most of the case, it is sufficient to determine the seismic design level of gravity type quay walls if the issue of human life safety or other sensitive factors can be neglected. Further-

more, even for other various infrastructures, the proposed procedure might be a good tool to discuss the seismic design scheme, especially in the determination of level-1 ground motion level.

Major conclusions obtained in this study are as follows.

- 1) Seismic risk evaluation for 280 ports in Japan was conducted. The results show that a quay wall in seismically active area has larger seismic risk than others even though it was designed with larger seismic coefficient.
- 2) An optimization procedure for design seismic coefficient for gravity type quay walls was proposed and applied for 280 ports in Japan. The results showed that the current regional design seismic coefficient was close to the optimum design seismic coefficient obtained by the proposed procedure.
- 3) Variation of the optimum seismic coefficient for the important quay wall or the quay wall with longer service life than usual was examined. Based on the proposed procedure, a reasonable definition for the importance factor becomes possible. For example, an importance factor of 1.5 and 1.2 in the current design procedure corresponds to four times and twice of importance (or duration of service life), respectively.
- 4) The relationship between peak ground acceleration and seismic coefficient was examined. The results indicate that the current conservative relation works well to define conservative optimum design seismic coefficients. Thus, the current design seismic coefficient is regarded reasonable since it is close to or conservative of the optimum design seismic coefficient.

ACKNOWLEDGMENT: The author expresses his sincere thanks to Ms. Elizabeth Hausler, Dr. Kazuomi Nagashima and Ms. Yoko Sato for their comments and help with English editing and Graphics.

REFERENCES

- 1) Japan Society of Civil Engineers: *Earthquake Resistant Design Codes in Japan*, 2000.
- 2) Noda, S., Uwabe, T. and Chiba, T.: Relation between seismic coefficient and ground acceleration for gravity type quay wall, *Report of the Port and Harbour Research Institute*, Vol.14, No.4, (in Japanese), 1975.
- 3) Nozu, A., Uwabe, T., Sato, Y. and Shinozawa, T.: Relation between seismic coefficient and peak ground acceleration estimated from attenuation relations, *Technical note of Port and Harbour Research Institute*, No.893, (in Japanese), 1997.
- 4) Uwabe, T.: Estimation of earthquake damage deformation and cost of quaywalls based on earthquake damage records, *Technical Note of Port and Harbour Research Institute*, No.473, 197p., (in Japanese), 1983.
- 5) Ichii, K.: A seismic risk assessment procedure for gravity type quay walls, *Journal of Structural Mechanics and Earthquake Engineering*, JSCE, Vol.19, No.2, 131s-140s, 2002.
- 6) Nakamura, T.: The Present and the Future of Seismic Risk Management, *Tsuchi to Kiso*, Vol.49, No.8, Japanese Geotechnical Society, pp.1-3, (in Japanese), 2001.
- 7) Ohtsu, H., Ohnishi, Y. and Mizutani, M.: The methodology associated with the stability analysis of slopes based on the concept of the performance based design, *Journal of Geotechnical Engineering*, JSCE, No.631/III-48, pp.235-243, (in Japanese), 1999.
- 8) Shumuta, Y., Ishida, K. and Tohma, J.: A method for seismic retrofit planning of substation components on the basis of the cost benefit analysis, *Journal of Structural Mechanics and Earthquake Engineering*, JSCE, No.584/I-42, pp.215-228, (in Japanese), 1998.
- 9) Ichii, K., Iai, S., Sato, Y. and Liu, H.: Seismic performance evaluation charts for gravity type quay walls, *Journal of Structural Mechanics and Earthquake Engineering*, JSCE, Vol.19, No.1, 21s-31s, 2002.
- 10) Iai, S., Matsunaga, Y. and Kameoka, T.: Strain space plasticity model for cyclic mobility, *Soils and Foundations*, Vol. 32, No. 2, pp.1-15, 1992.
- 11) Iai, S., Kurata, E. and Tsuchida, H.: Digitization and correction of strong-motion accelerograms, Technical note of the Port and Harbour Research Institute, No.286, (in Japanese), 1978.
- 12) Working group for new seismic design development: The report of new seismic design development working group, research committee in bureau of port and harbours, Ministry of transport, (in Japanese), 1987.

(Received March 6, 2002)

トータルコストに基づく重力式岸壁の設計震度の最適化

一井康二

重力式岸壁の設計震度の最適化手法と現行の地域別震度の背景について検討した。まず、日本の280港における地震リスク解析を行い、初期建設費と地震被害による復旧費用の期待値の合計であるトータルコストを最小化するように、各港における最適な設計震度を求めた。次に、重要性や供用期間に応じた最適な設計震度について検討した。最後に、地震危険度解析により求まる地盤加速度と最適な設計震度との関係について検討した。検討の結果、現行の基準における設計震度は、最適な設計震度に近い安全側の値を与えており、妥当な値であることがわかった。