

A STUDY ON MOISTURE DIFFUSION IN DRYING  
AND DRYING SHRINKAGE OF CONCRETE

(Reprinted with permission from CEMENT AND CONCRETE RESEARCH  
Vol.13, pp.216-224, Copyright 1983, Pergamon Press, Ltd.)



Kenji SAKATA

SYNOPSIS

It is the purpose of this paper to clarify the behavior of moisture existing in concrete as drying occurs, and the relationship between moisture loss and drying shrinkage. Assuming that the behavior of moisture existing in concrete when drying was governed by nonlinear diffusion equation, the diffusion coefficient was expressed as a function of the moisture content by the experiment. The surface factor was also determined by the experiment. The relationship between diffusion coefficient or surface factor and the water-cement ratio of concrete were given. It was shown that the shrinkage strain was closely related to moisture loss.

---

K.SAKATA is an associate professor of the Department of Civil Engineering at Okayama University, Okayama, Japan. He received his Doctor of Engineering Degree in 1976 from Kyoto University. His research interests include problems concerning prediction of shrinkage and creep of concrete and fatigue properties of concrete. He is a member of JSCE, JCI and JSMS.

---

A STUDY ON MOISTURE DIFFUSION IN DRYING  
AND DRYING SHRINKAGE OF CONCRETE

Kenji Sakata  
Department of Civil Engineering  
School of Engineering, Okayama University  
Tsushima-naka 3-1-1, Okayama, Japan

(Refereed)

(Received July 21; in final form Nov. 18, 1982)

ABSTRACT

It is the purpose of this paper to clarify the behavior of moisture existing in concrete as drying occurs, and the relationship between moisture loss and drying shrinkage. Assuming that the behavior of moisture existing in concrete when drying was governed by nonlinear diffusion equation, the diffusion coefficient was expressed as a function of the moisture content by the experiment. The surface factor was also determined by the experiment. The relationship between diffusion coefficient or surface factor and the water-cement ratio of concrete were given. It was shown that the shrinkage strain was closely related to moisture loss.

Introduction

The mechanism of drying shrinkage of concrete has been explained by the so-called seepage theory where moisture in concrete is diffused outside accompanying drying. Therefore, when discussing drying shrinkage of concrete, it is necessary to clarify the behavior of moisture existing in concrete as drying occurs.

According to Pickett (1), if the flow of water in concrete were to be entirely by diffusion of vapor, if the vapor pressure of the water in the concrete were proportional to the moisture content, and if permeability were independent of the moisture content, then the differential equation for the flow of water would be a diffusion equation. He solved a linear diffusion equation by using Newton's law of heat transfer at exposed boundaries. The study by Pickett is very suggestive in discussing shrinkage.

In recent studies (2,3), however, it has been shown that moisture diffusion cannot be expressed by the linear equation, and therefore, a nonlinear diffusion equation must be used.

From this point of view, the author presents in this study a method of predicting the time-dependent phenomena of moisture diffusion and distribution of water in concrete using the nonlinear diffusion theory. The author determines

the diffusion coefficient and surface factor, and the relationship between these values and the properties of concrete by experiments. The relationship between moisture loss and drying shrinkage strain is also discussed.

Prediction of Moisture Distribution in Concrete  
by Nonlinear Diffusion Equation

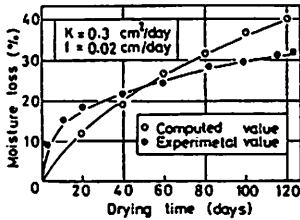

FIG. 1

The comparison between experimental values and computed values by linear equation.

Fig. 1 shows the relationship between moisture loss predicted by linear equation and test values for beam specimens of dimensions 10 x 10 x 40 cm. The diffusion equation and the moisture loss are given below:

$$\frac{\partial C}{\partial t} = K \left( \frac{\partial^2 C}{\partial x^2} + \frac{\partial^2 C}{\partial y^2} + \frac{\partial^2 C}{\partial z^2} \right) \text{----- (1)}$$

Where C = moisture content (kg/l), K = diffusion coefficient (cm<sup>2</sup>/day).

$$\int_V C \, dv = \sum_{n=1}^n \sum_{m=1}^m \sum_{l=1}^l \frac{2\mu^2}{\alpha_n^2 \{(\alpha_n^2 + \mu^2)a + 2\mu\}} \cos^2 \alpha_n a \cdot \left\{ \cos \alpha_n a + \frac{\alpha_n^2 - \mu^2}{\alpha_n^2 + \mu^2} \right\}^2$$

$$\cdot \frac{2\mu^2}{\beta_m^2 \{(\beta_m^2 + \mu^2)b + 2\mu\}} \cos^2 \beta_m b \cdot \left\{ \cos \beta_m b + \frac{\beta_m^2 - \mu^2}{\beta_m^2 + \mu^2} \right\}^2$$

$$\cdot \frac{2\mu^2}{\gamma_l^2 \{(\gamma_l^2 + \mu^2)c + 2\mu\}} \cos^2 \gamma_l c \cdot \left\{ \cos \gamma_l c + \frac{\gamma_l^2 - \mu^2}{\gamma_l^2 + \mu^2} \right\}^2$$

$$\cdot \exp(-Kk^2 t) \text{----- (2)}$$

where  $\alpha_n, \beta_m, \gamma_l$  = eigenvalues in the direction of the x, y and z axes, respectively, a, b and c = width, depth and length of the beam specimen, respectively,  $\mu = f/K$ , f = surface factor (cm/day), K = diffusion coefficient (cm<sup>2</sup>/day), k = constant, and t = time (day). As is evident from Fig. 1, the numerical values by Eq. (2) give very poor correlations with test data, and in the early period of drying, test values are larger than numerical ones. Therefore, K should be made a function of moisture content (C). Then, the equation governing this phenomenon becomes a nonlinear diffusion equation as given below:

$$\frac{\partial C}{\partial t} = \text{div} (K \text{ grad } C) \text{----- (3)}$$

In this study, Eq. (3) is formulated by the finite element method (4,5). However, the details are not given in this paper.

In the numerical analysis of nonlinear diffusion equation, the diffusion coefficient must be determined as a function of the moisture content at each time step. This is determined by experiments. For the assumed values f and K obtained by the experiments, Eq. (3) is solved by the finite element technique, and then time-dependent phenomena of the total moisture diffusion from the specimen can be obtained. Comparing the calculated results with the experimental ones, the suitable values of f and K can be obtained.

TABLE 1  
The mixes of concretes

Kind of specimen	W/C (%)	W (kg/m <sup>3</sup> )	C (kg/m <sup>3</sup> )	S/a (%)	S (kg/m <sup>3</sup> )	G (kg/m <sup>3</sup> )
A	48.3	203	420	44	731	926
B	43.6	183	420	44	754	996
C	50.1	213	420	44	720	912
D	56.4	203	360	44	753	954
E	42.3	203	480	44	709	899
F	48.3	203	420	42	698	959
G	48.3	203	420 </td <td>46</td> <td>764</td> <td>893</td>	46	764	893

TABLE 2  
The properties of concretes

Kind of specimen	Age (days)	E <sub>c</sub>	σ <sub>c</sub>
		MPa × 10 <sup>3</sup>	MPa
A	7	27.2	34.1
	14	27.9	35.2
	28	31.1	44.3
B	28	30.9	49.1
C	28	30.4	37.9
D	28	28.9	33.7
E	28	31.9	50.4
F	28	31.2	40.2
G	28	31.0	42.3

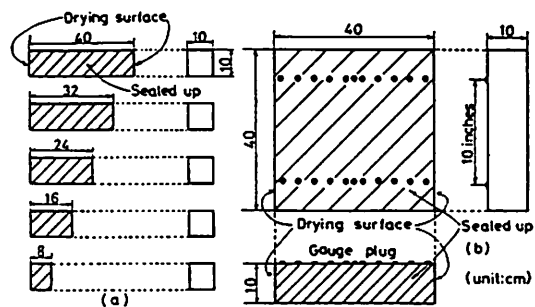

FIG. 2

The shapes and dimensions of specimens.

### Experiments

The cement used in these tests is ordinary portland cement, the coarse aggregate is crushed stone, and the fine aggregate is marine sand. The mix proportions of concretes, and the compressive strengths and moduli of elasticity are shown in Table 1 and 2, respectively. The experimentation procedure by which the diffusion coefficient is determined as a function of moisture content is the one based on weight changes of various-length specimens. Fig. 2(a) shows the shapes and dimensions of specimens. The four sides of each specimen are sealed with vinyl paint and paraffin wax, while the two end sides are not sealed. Therefore, moisture diffusion becomes a one-dimensional problem. Fig. 2(b) shows the shape and dimensions of specimen used to measure drying shrinkage strains at various depths from the drying surface. The four surfaces other than the ones from which drying is to occur are also sealed.

The weight changes and strains of specimens were measured by the table balance (capacity: 10kg; accuracy: 1g) and Whittemore strain meter (gauge length: 10 in.), respectively. The tests were performed in a constant-temperature, constant-humidity room of 20°C ± 1deg. and 60% R.H.

Relationships between moisture losses from the specimens in Fig. 2(a) and time were obtained by the experiments. If the distribution of moisture at a distance  $x$  from the drying surface is assumed to be the same without regard to the length of the specimen, the moisture content  $C(x,t)$  at time  $t$  and at distance  $x$  ( $x=2, 6, 10, 14, 18$ cm) is given by the following equation:

$$C_i(x_i, t) = \left(1 - \frac{w_i - w_{i-1}}{w_0(l_i - l_{i-1})S}\right) \times 100 \text{ ----- (4)}$$

where  $l_i$  is length of specimen (cm),  $w_i$  is moisture loss of the specimen (of length of  $l_i$ ) at time  $t$  (g),  $w_0$  is diffusible moisture in a unit volume (kg/l), and  $S$  is area of drying surface (cm<sup>2</sup>).

The diffusible moisture is given by the difference between the weight of the specimen at the start of drying and its absolute weight on oven drying (80°C) after the experiment.

### Test Results and Discussion

#### 1. Determination of Diffusion Coefficient.

The one-dimensional diffusion equation is as follows:

$$\frac{\partial C}{\partial t} = \frac{\partial}{\partial x} \left( K \frac{\partial C}{\partial x} \right) \text{ ----- (5)}$$

If  $\tau$  is assumed to be a function of a single value,  $\tau = x/\sqrt{t}$ , Eq. (5) becomes the equation below by Boltzman's transformation (6).

$$K(C) = \int_{C_s}^C \lambda dC / 2 \left( \frac{dC}{d\lambda} \right) \text{ ----- (6)}$$

where:  $K(C)$  = diffusion coefficient as a function of  $C$ ,  $C_s = 100\%$ .

Fig. 3 shows an example of the relationship between the moisture losses by drying of the various-length specimens and drying time. Calculating the result by Eq. (4), the time-dependent changes in moisture content at depth  $x$  from the drying surface are shown in Fig. 4. According to Fig. 4, the change in moisture content at  $x = 2$ cm, or near the surface of concrete, is sharp, but at points slightly deeper inside, the changes are slow. Fig. 5 shows the distribution of water content at 98 days from the start of drying versus depths from the drying surface.

It may be seen from the above that drying of concrete is rapid at the very surface portion in contact with outside air, but is extremely slow at deeper portions in the interior.

In Fig. 6, the results shown in Fig. 4 are plotted with the above-mentioned variable  $\lambda$  on the abscissa and moisture content  $c$  on the ordinate. The curves in

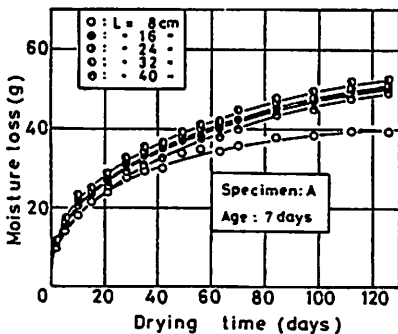

FIG. 3

Moisture loss~time curves

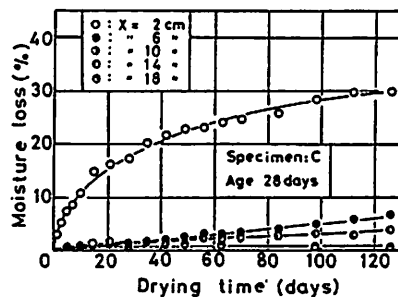

FIG. 4

The time-dependent changes in moisture content at depth  $x$  from the drying surface

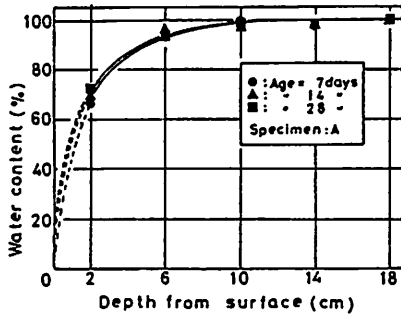

FIG. 5

The distribution of water content at 98 days from the start of drying.

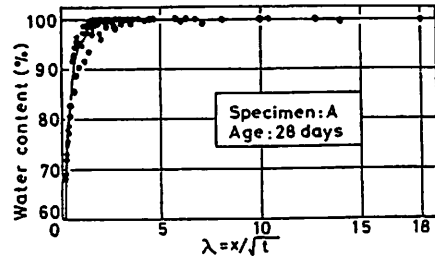

FIG. 6

The relationship between  $\lambda$  and moisture content.

Fig. 6 are given by Eq. (7).  $C = 100\{1 - (\frac{a-\lambda}{b})^n\}$  ----- (7)

The constants  $a$ ,  $b$  and  $n$  are summarized in Table 3. Diffusion coefficients are calculated by Eq. (6) and (7), and the relationships between them and moisture content are shown in Fig. 7.

It is consequently suggested that moisture diffusion from the interior of concrete is closely related to the moisture content of the concrete. More precisely, in the range of high moisture content, the diffusion coefficient falls sharply with decrease in moisture content, but with moisture content below 70 to 80%, it may be considered to be more or less constant. This tendency is the same for other specimens in these tests and was also reported by Bazant and Najjar (2).

The relationships between  $K(C)$  and  $C$  in Fig. 7 are approximated by Eq. (8).

$$K(C) = K_0 + \frac{K_s - K_0}{1 + (\frac{100-C}{100-C_c})^{n_0}} + \frac{K_s - K_0}{1 + (\frac{100-C}{100-C_c})^{n_0}} \cdot \frac{C-100}{100} \text{ ----- (8)}$$

where:  $K_s$  is diffusion coefficient in saturated condition or  $C = 100\%$ ,  $K_0$  is diffusion coefficient in oven-dry condition or  $C = 0\%$ ,  $C_c$  is moisture content at inflection point of curve, and  $n_0$  is constant.

In this study,  $C$  is the specific moisture content, not the pore relative humidity as is evident from the above-mentioned experimentation procedure. On the other hand, Bazant and Najjar (2) proposed Eq. (9) using pore relative humidity.

$$K(C) = K_0 + \frac{K_s - K_0}{1 + (\frac{100-C}{100-C_c})^{n_0}} \text{ ----- (9)}$$

The results of this experiment are approximately expressed by Eq. (9). But, by Eq. (9),  $K(C)$  is not equal to  $K_0$  at  $C=0\%$ . So, the author modified Eq. (9), and proposed Eq. (8).

The values of  $n_0$ ,  $K_s$ ,  $K_0$  and  $C_c$  for the various specimens are summarized in Table 4. As is evident from this Table, the diffusion coefficient at the start of drying are about 0.5 to 1.0  $\text{cm}^2/\text{day}$ . These results are different from those of previous studys using the linear theory (for example, Pickett: 0.23 $\text{cm}^2/\text{day}$ , and author: 0.30 $\text{cm}^2/\text{day}$ ).

TABLE 3  
The constants of Eq. (7)

Kind of specimen	Age (days)	Water content (%)	a	b	n
A	28	0~92	18.00	18.0	60
		92~100	18.00	18.0	30
	7	0~92	18.00	18.0	60
		92~100	17.25	18.0	60
	14	0~100	18.00	18.0	60
	B	28	0~85	17.88	18.0
85~100			17.56	18.0	40
C	28	0~92	17.75	18.0	60
		92~100	17.38	18.0	30
D	28	0~90	18.00	18.0	60
		90~100	18.00	18.0	40
E	28	0~90	17.88	18.0	60
		90~100	16.56	18.0	20
F	28	0~93	18.00	18.0	60
		93~100	17.88	18.0	50
G	28	0~100	17.75	18.0	40

TABLE 4  
The constants of Eq. (8)

Kind of specimen	Age (days)	$K_0$ (cm <sup>2</sup> /day)	$K_s$ (cm <sup>2</sup> /day)	$C_c$ (%)	$n_0$
A	28	0.047	0.76	98.5	0.81
	7	0.047	0.76	98.5	0.81
	14	0.044	0.34	99.5	0.28
B	28	0.031	0.55	97.5	0.79
C	28	0.026	1.20	98.0	1.10
D	28	0.046	0.65	98.0	0.80
E	28	0.036	1.21	94.5	1.65
F	28	0.045	0.48	98.5	0.57
G	28	0.056	0.63	98.0	0.52

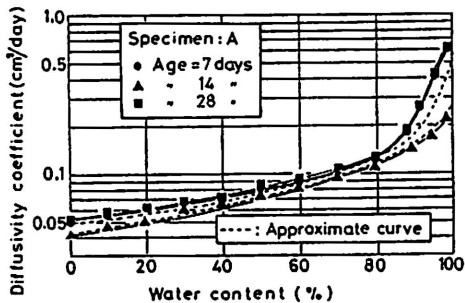

FIG. 7

The relationship between moisture content and diffusion coefficient

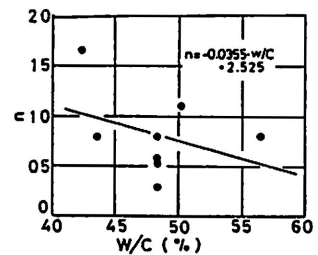

FIG. 8

The relationship between  $n_0$  and water-cement ratio

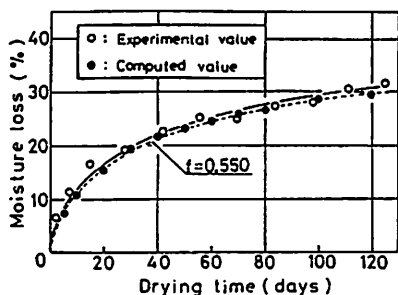

FIG. 9  
Determination of surface factor

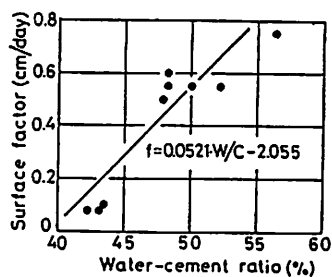

FIG. 10  
The relationship between surface factor and water-cement ratio of concrete

In general, drying shrinkage is a problem when concrete is green or in a condition of high moisture content. In such a case, it is desirable that diffusion coefficient is determined as a function of moisture content. Fig. 8 shows the relationship between the constant  $n_0$  and water-cement ratio.

## 2. Determination of Surface Factor

The surface factor is determined by the above-mentioned procedure. The model used in this study is composed of 51 nodal points and 32 four-node isoparametric elements. The initial and boundary conditions are respectively as follows:

$$\left. \begin{aligned} C(x,y,0) &= 100\% \\ K\left(\frac{\partial C}{\partial x}\right)_s &= f(C_e - C_s) \end{aligned} \right\} \text{----- (10)}$$

where:  $f$  = surface factor (cm/day),  $C_e$  = environmental humidity,  $C_s$  = moisture content at the surface or the neighborhood in the interior of concrete.

Fig. 9 shows an example of comparison between computed and experimental values. The surface factors by this procedure are given in Table 5 while Fig. 10 shows the relationship between these values and water-cement ratios of concrete. According to Fig. 10, surface factor increases with water-cement ratio.

TABLE 5  
Test results

Kind of specimen	Age (days)	Shrinkage strain $S_{98}(\times 10^{-5})$	Moisture loss $W_{98}(g)$	Capacity of moisture loss $W_0 (kg/\lambda)$	Surface factor $f(\text{cm/day})$
A	28	37.50	33.1	0.147	0.550
	7	37.00	38.4	0.144	0.600
	14	37.00	35.9	0.146	0.600
B	28	28.50	24.7	0.131	0.100
C	28	38.50	35.9	0.158	0.550
D	28	33.75	42.2	0.158	0.750
E	28	36.00	25.8	0.139	0.075
F	28	47.25	35.2	0.147	0.550
G	28	33.75	32.1	0.145	0.550



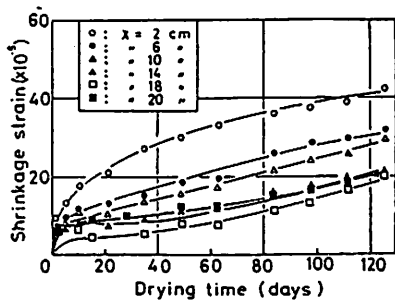

FIG. 11

Shrinkage strain~time curves

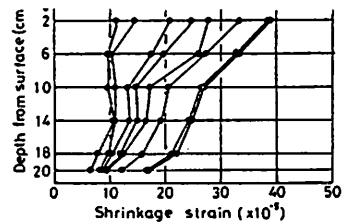

FIG. 12

The distribution of shrinkage strain

### 3. Relationship between Shrinkage and Moisture Loss

Fig. 11 shows an example of the relationships between shrinkage strain at depth  $x$  from the drying surface and drying time. These shrinkage strains are obtained by the experiment using the specimen shown in Fig. 2(b). Shrinkage strains for  $x = 2\text{ cm}$  at 98 days from start of drying and total moisture loss for 98 days are summarized in Table 5. In Fig. 11, it appears that shrinkage strain in the neighborhood of the drying surface increases rapidly at the early stage of drying, but at around 120 days the rate of increase declines slightly. However, deeper inside the concrete, the strain itself is small at about 120 days and the rate of increase does not fall off so much. These phenomena are very similar to those in case of moisture diffusion. Fig. 12 shows the relationships between shrinkage strains and the depth from the drying surface with the drying time at the parameter by the experiment.

Fig. 13 shows shrinkage strains against local moisture losses at depth  $x$  and a depth close to the drying surface ( $x = 2\text{ cm}$ ). The local moisture losses are obtained by calculating the experimental results by Eq. (4).

Pickett (1) reported that the shrinkage of concrete is a linear function of moisture loss from the interior of concrete. According to Fig. 13, the relationships between moisture losses and shrinkage strains in the neighborhood of the drying surface are expressed by almost straight lines. It is thus possible for shrinkage strain to be predicted by moisture loss so far as strain at the surface of concrete is concerned.

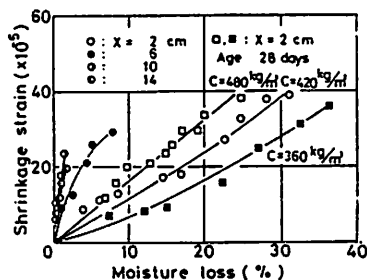

FIG. 13

The relationships between drying shrinkage strain and moisture losses

### Conclusions

The results of this study may be summarized as follows:

- 1) The diffusion coefficient governing moisture diffusion from concrete is dependent on the moisture content in the concrete. In effect, it is almost constant (about  $0.05\text{ cm}^2/\text{days}$ ) in the range of low moisture content (below about 80%), while at high moisture content or in the early period of drying, it increases with the moisture content.

2) The relationship between diffusion coefficient and moisture content can be expressed by the S-shaped curve given by Eq. (8), and its constant  $n_0$  decreases with increase in water-cement ratio. Regardless of the mix proportions,  $C_c$  may be taken to be approximately 98%.

3) Surface factor has a close relationship with water-cement ratio of concrete.

4) Moisture diffusion is rapid and in large quantity in the neighborhood of the drying surface, but in the interior of concrete, it is extremely slow and of small quantity.

5) Shrinkage strain of concrete differs according to depth from the drying surface, and strain at the surface is greater than in the interior of concrete. Furthermore, shrinkage strain is closely related to moisture loss, and especially for the neighborhood of the drying surface the relation can be expressed by a straight line.

#### References

1. G. Pickett, J. of ACI 17, 165 (1946).
2. Z.P. Bazant, L.J. Najjar, *Materiaux et Constructions* 5, 3 (1972).
3. N.K. Becker, C. Macinnis, J. of ACI 69, 652 (1973).
4. R.M. Polivka, E.L. Wilson, *Finite Element Analysis of Nonlinear Heat Transfer Problems*, University of California, Berkeley (1976).
5. K. Sakata, M. Nishigaki, O. Kuramoto, *Reports of Research and Development, Okayama University Computer Center* 1, 11 (1980).
6. J. Crank, *The Mathematics of Diffusion*, p. 148, Oxford at the Clarendon Press (1955).