

大聖牛之圖

中聖牛右准木品重蛇籠寸間劣凡

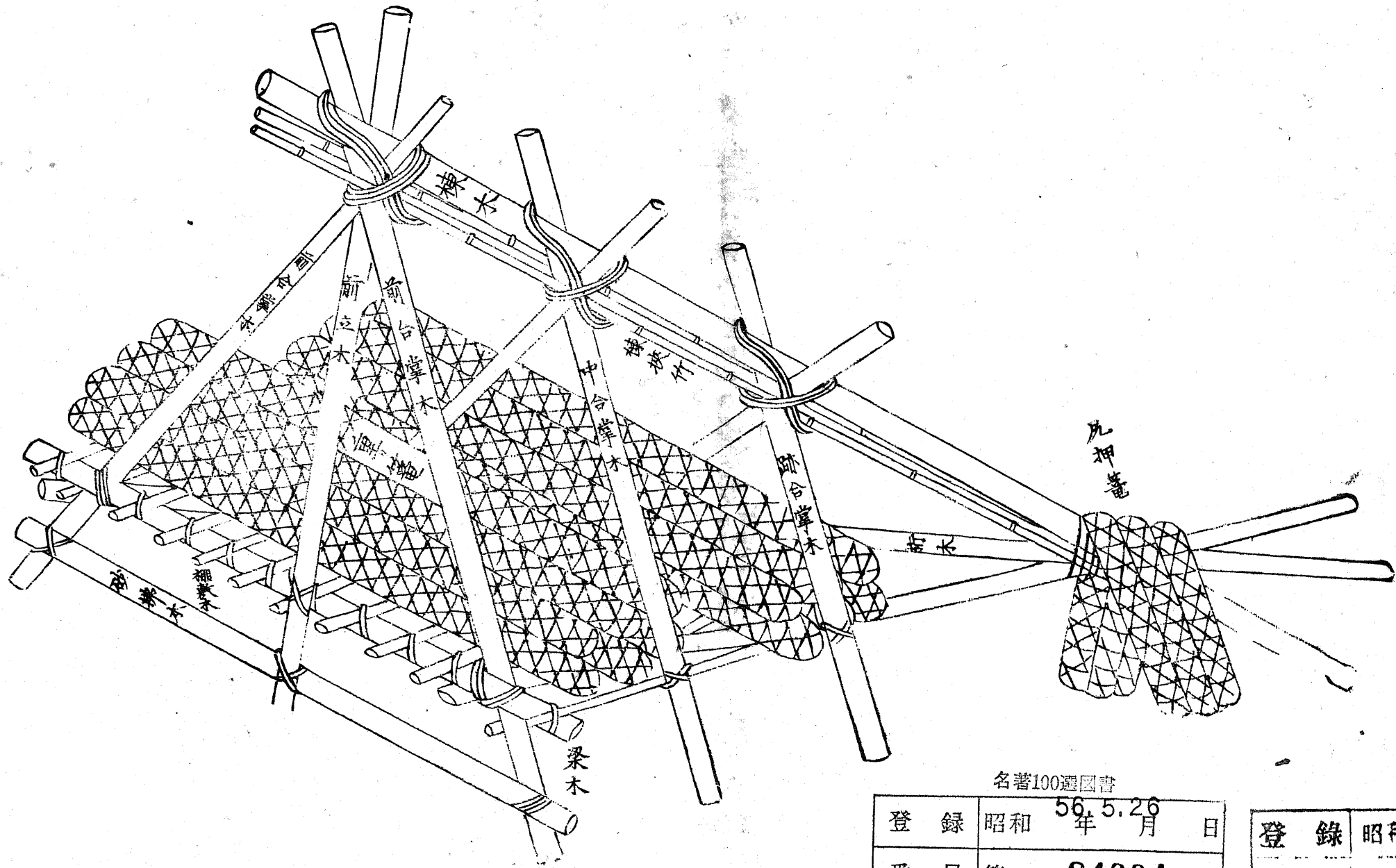

名著100選図書

登録	昭和	56	年	5	月	日
番号	第	24084	号			
社団法人	土木学会					
附属	土木図書館					

登録	昭和	30	年	11	月	22	日
番号	和	第	843	号			
社団法人	土木学会						

以下調製済

川倉之圖

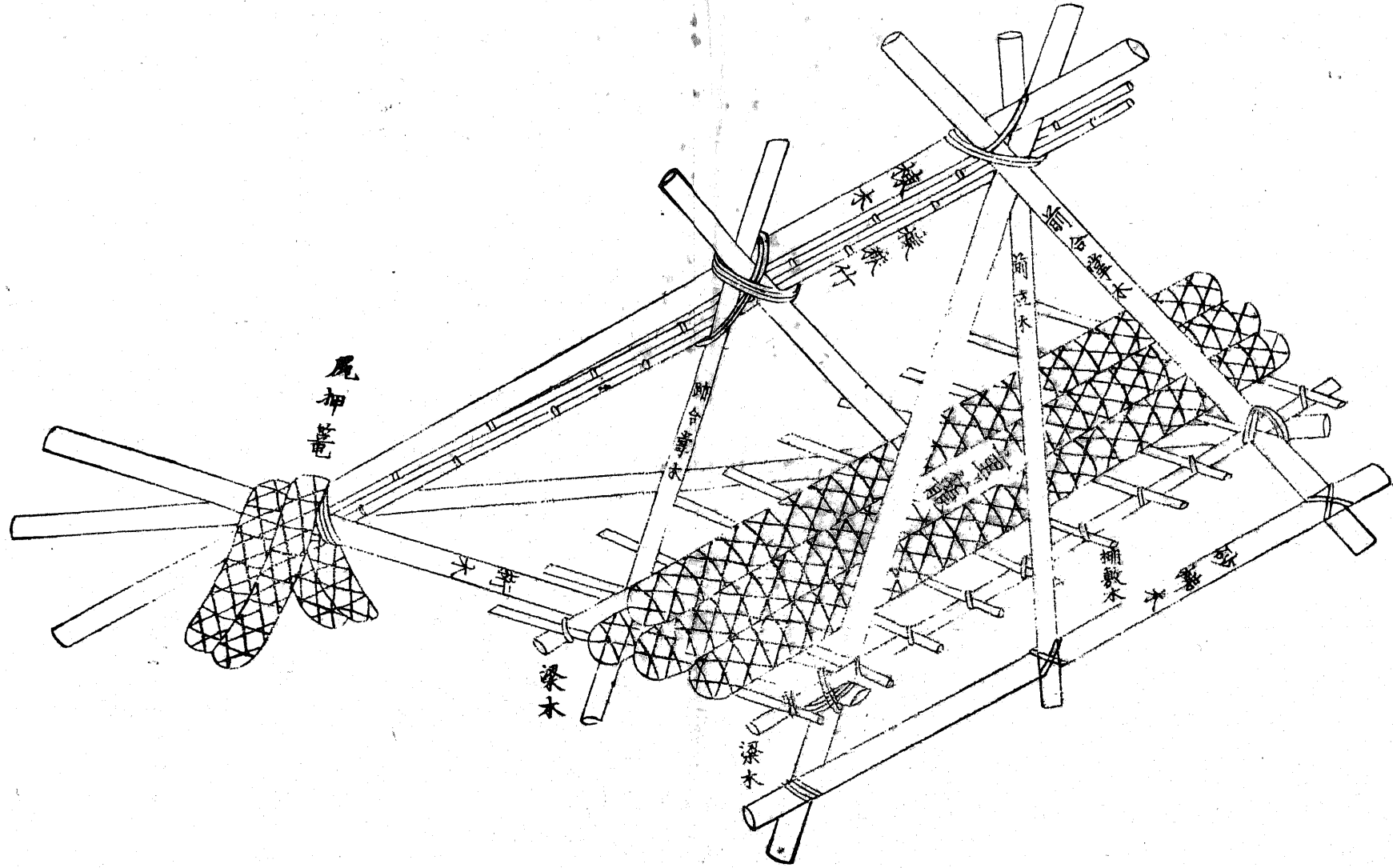

棚牛之圖

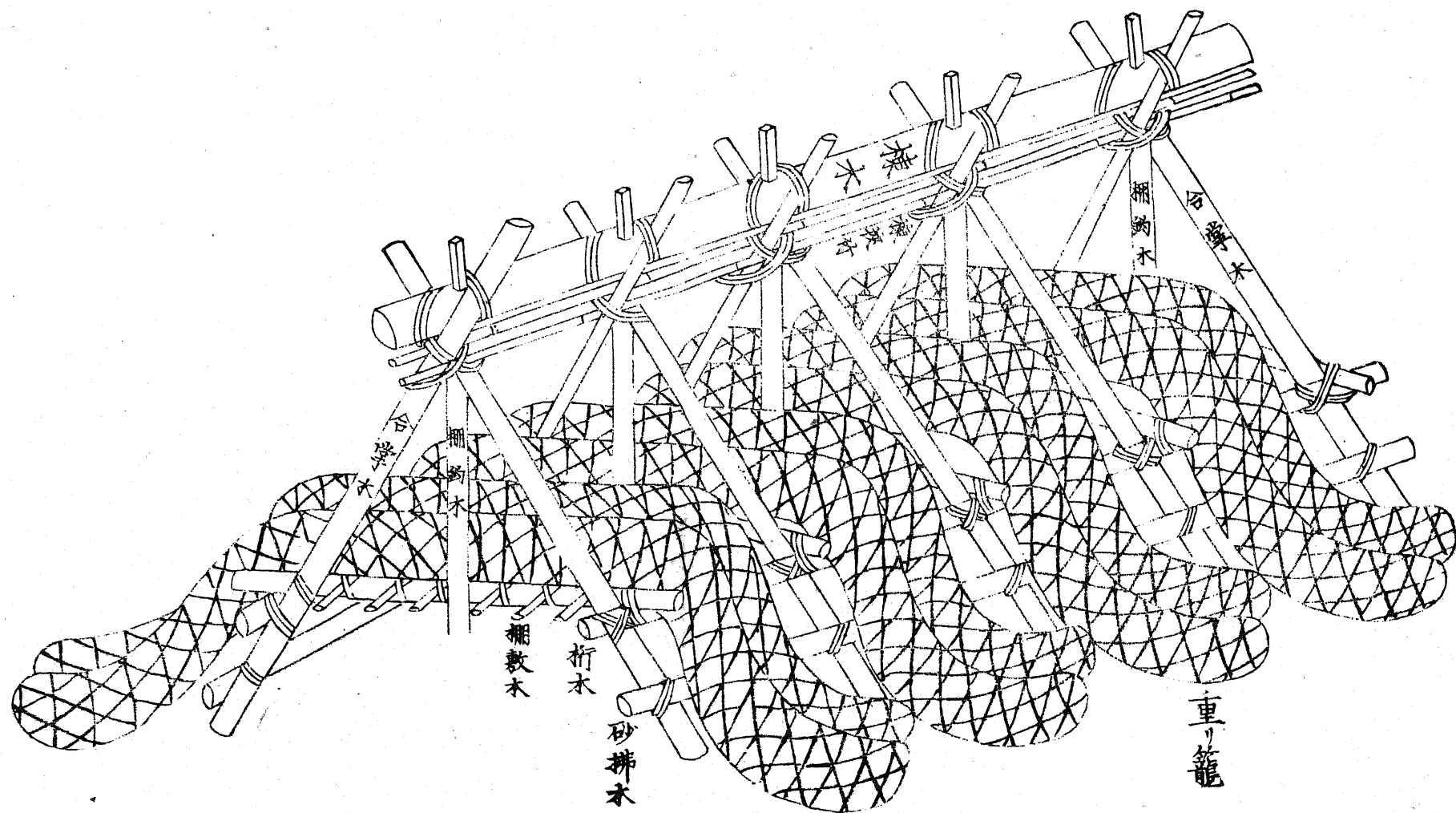

中菱牛之圖

大菱牛右三准レ木呂重葺寸間増

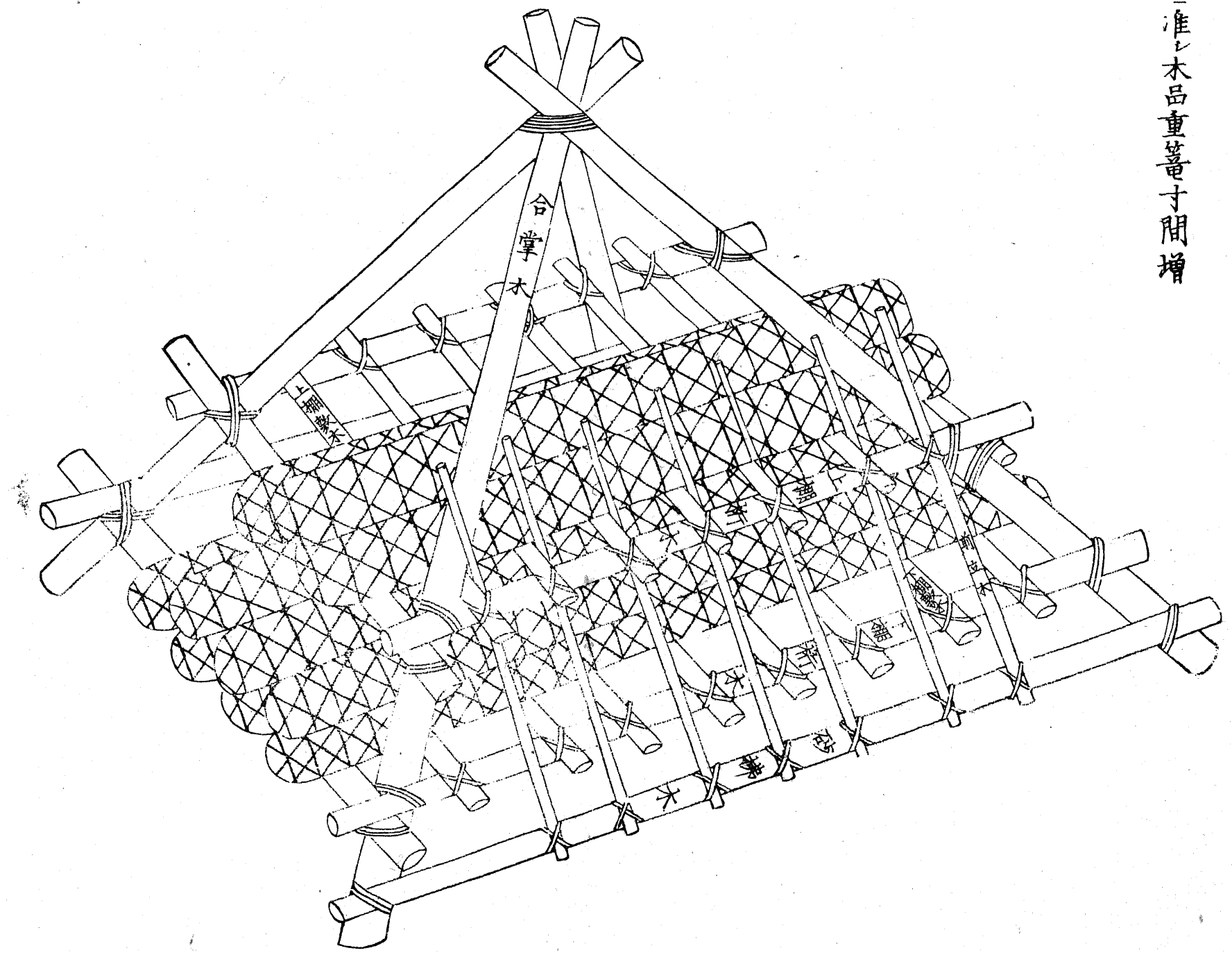

菱牛之圖

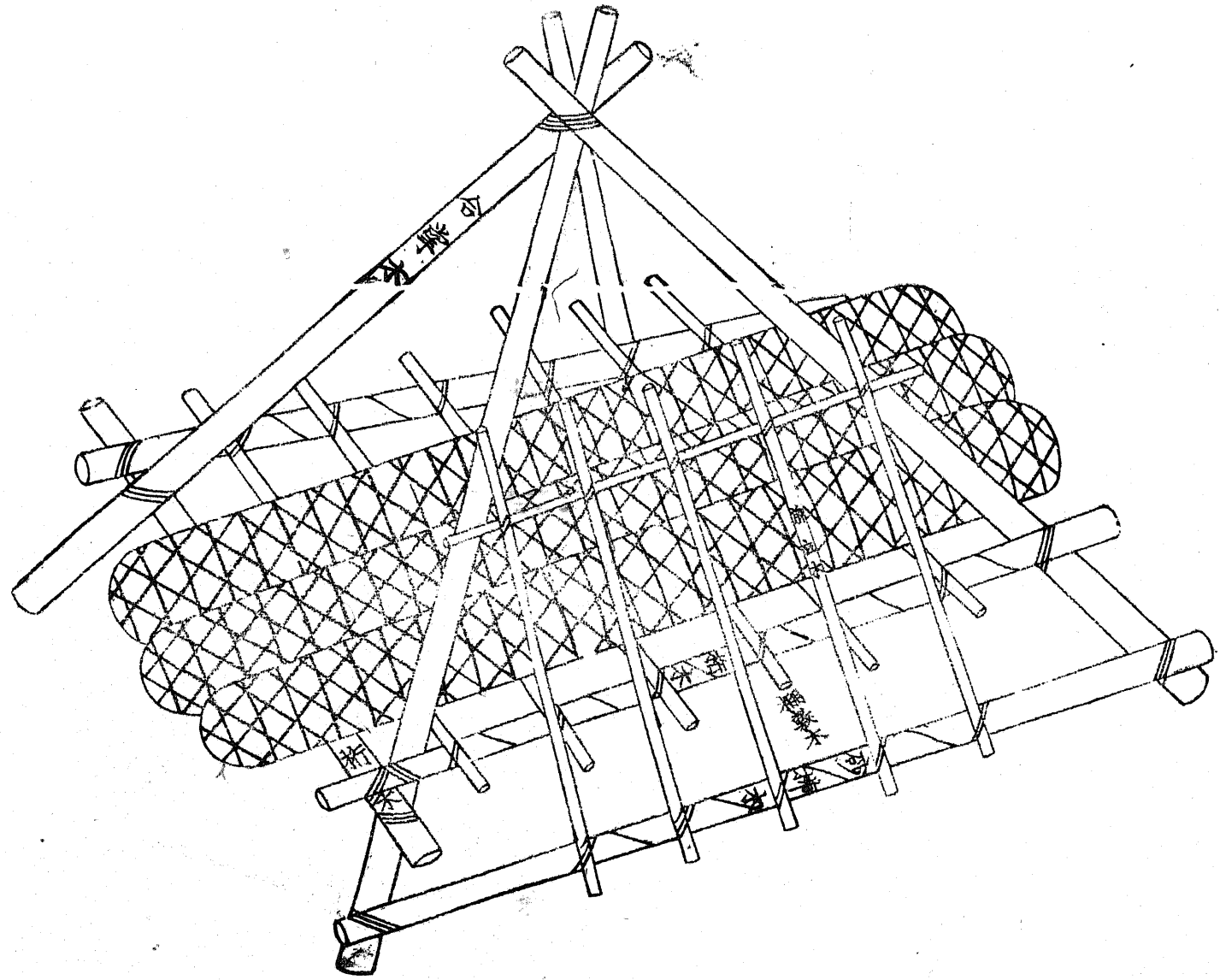

尺木垣之圖

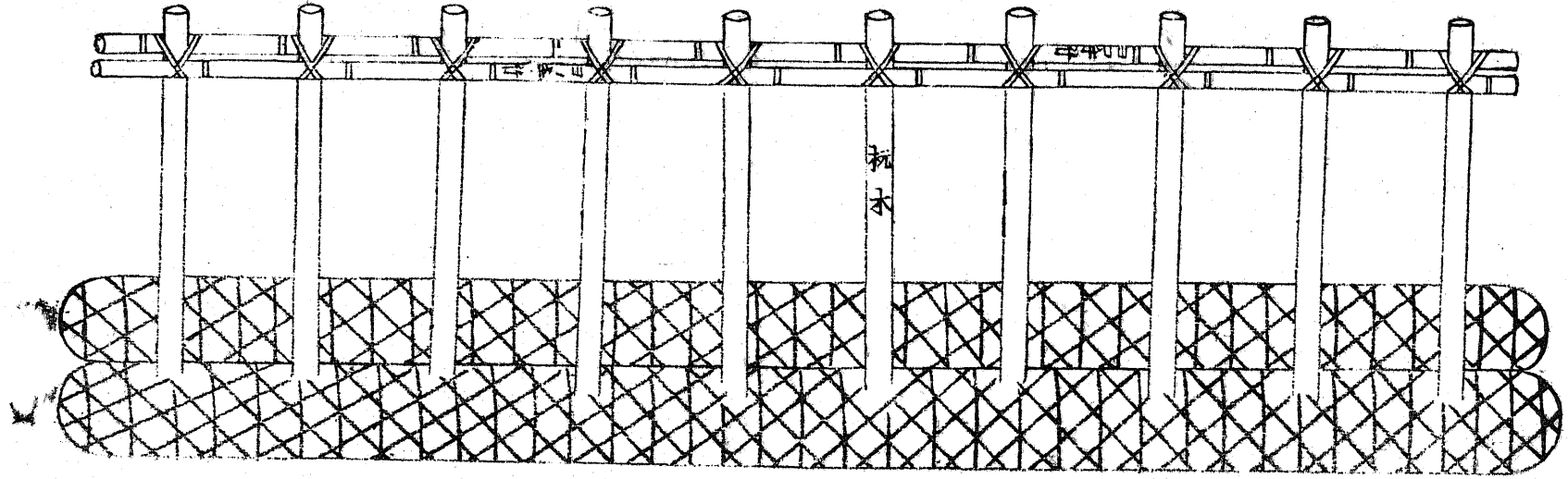

松木

根堅篋

尺木牛之圖

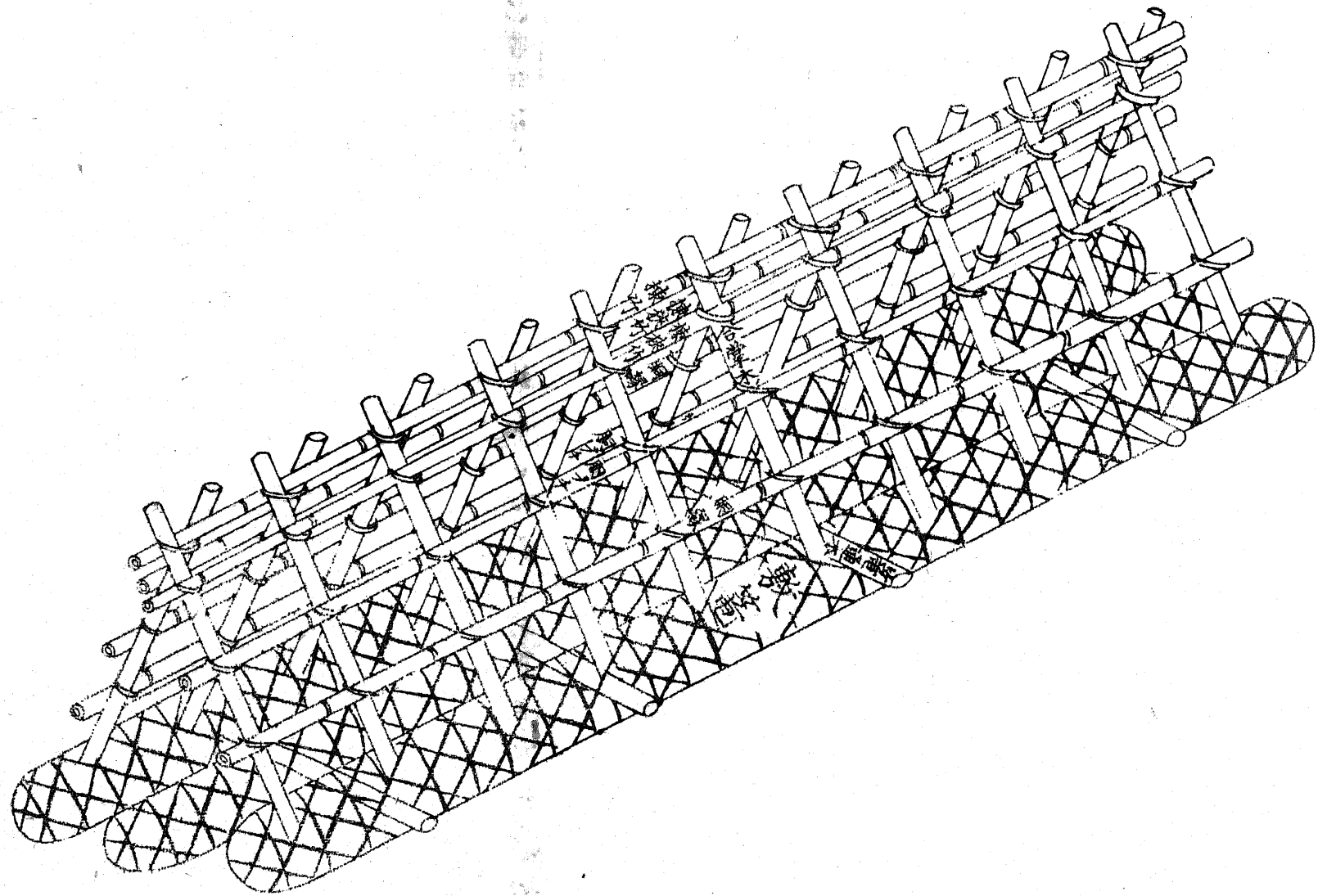

七

7

笈牛之圖

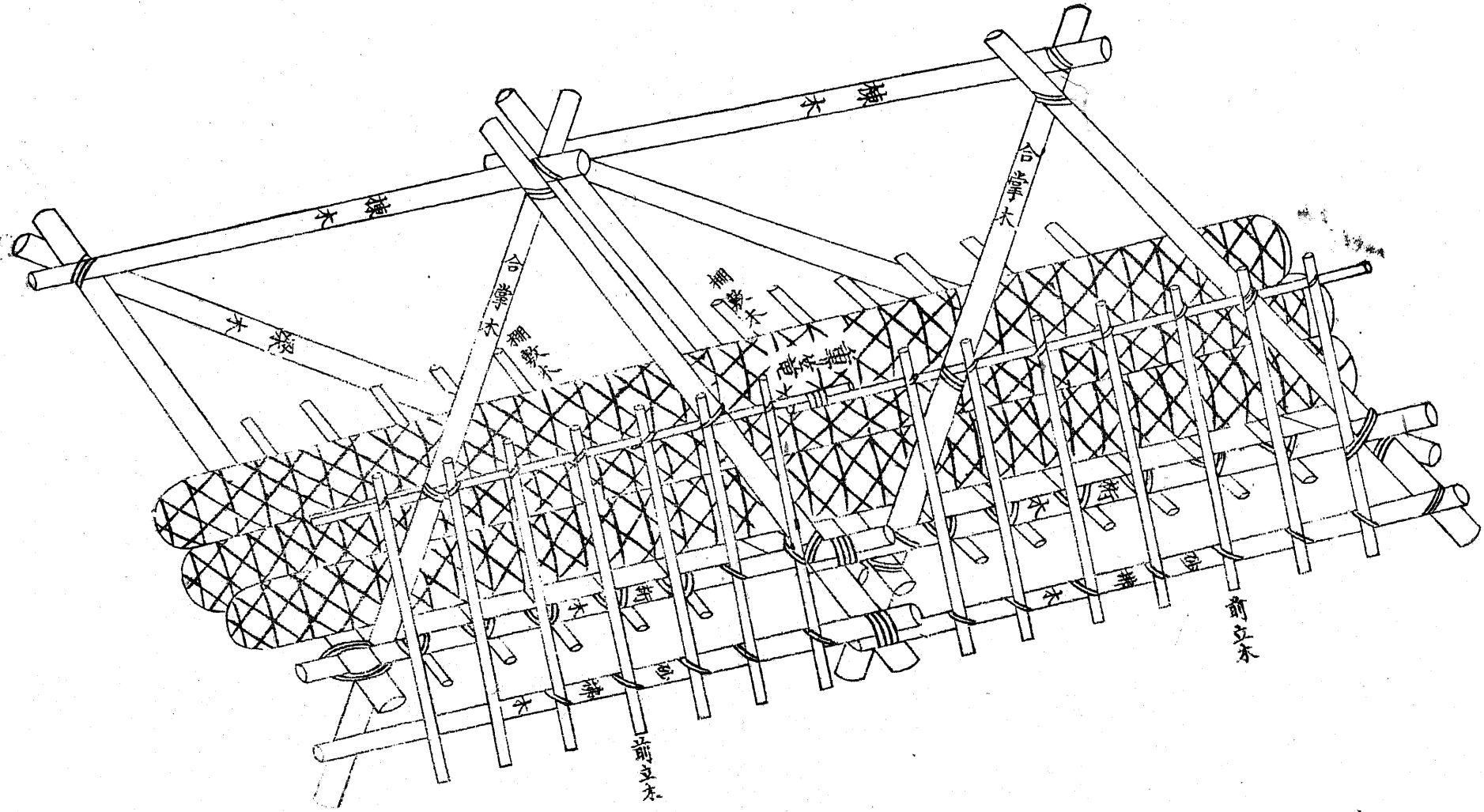

合掌柵之圖

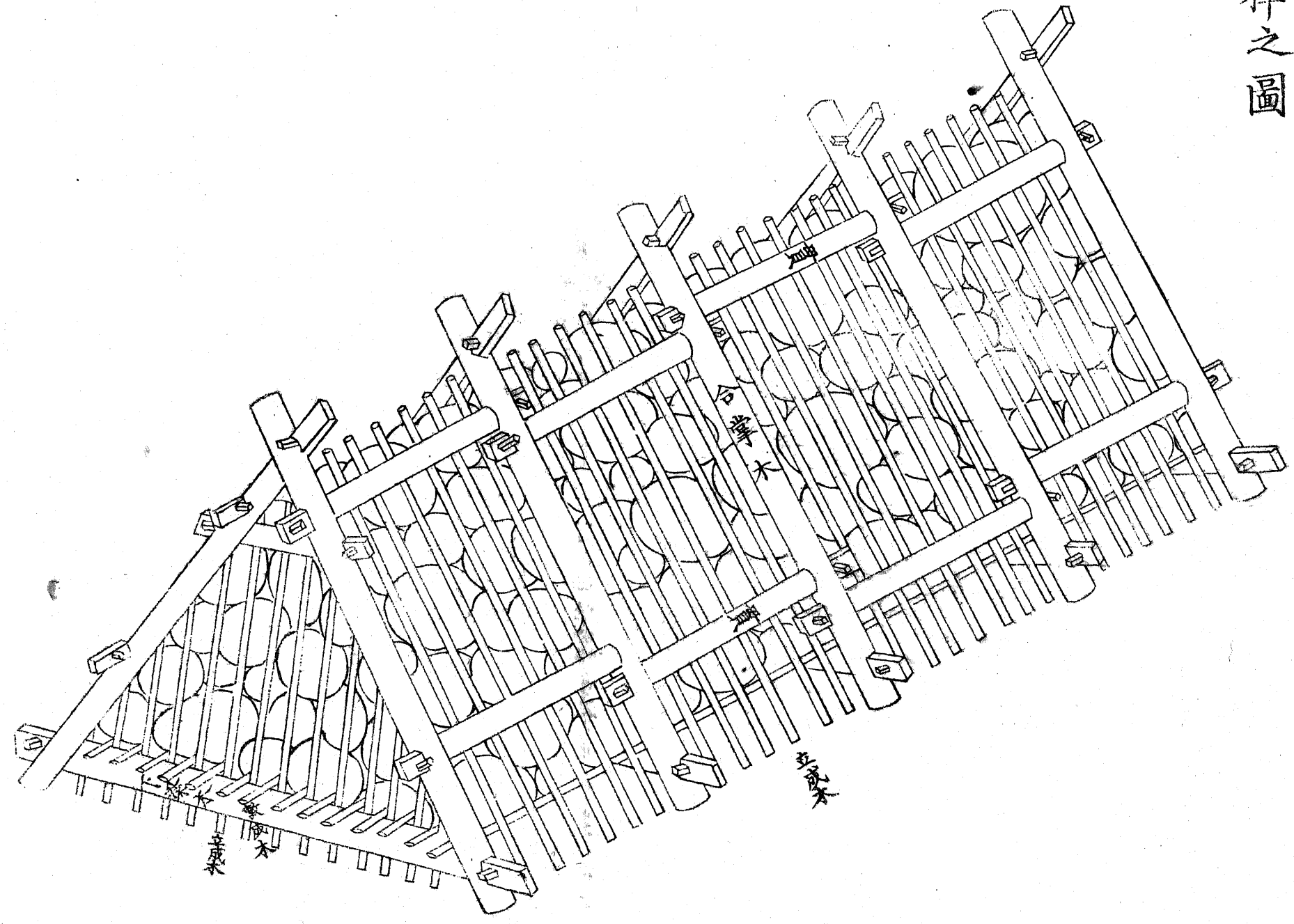

洞木牛之圖

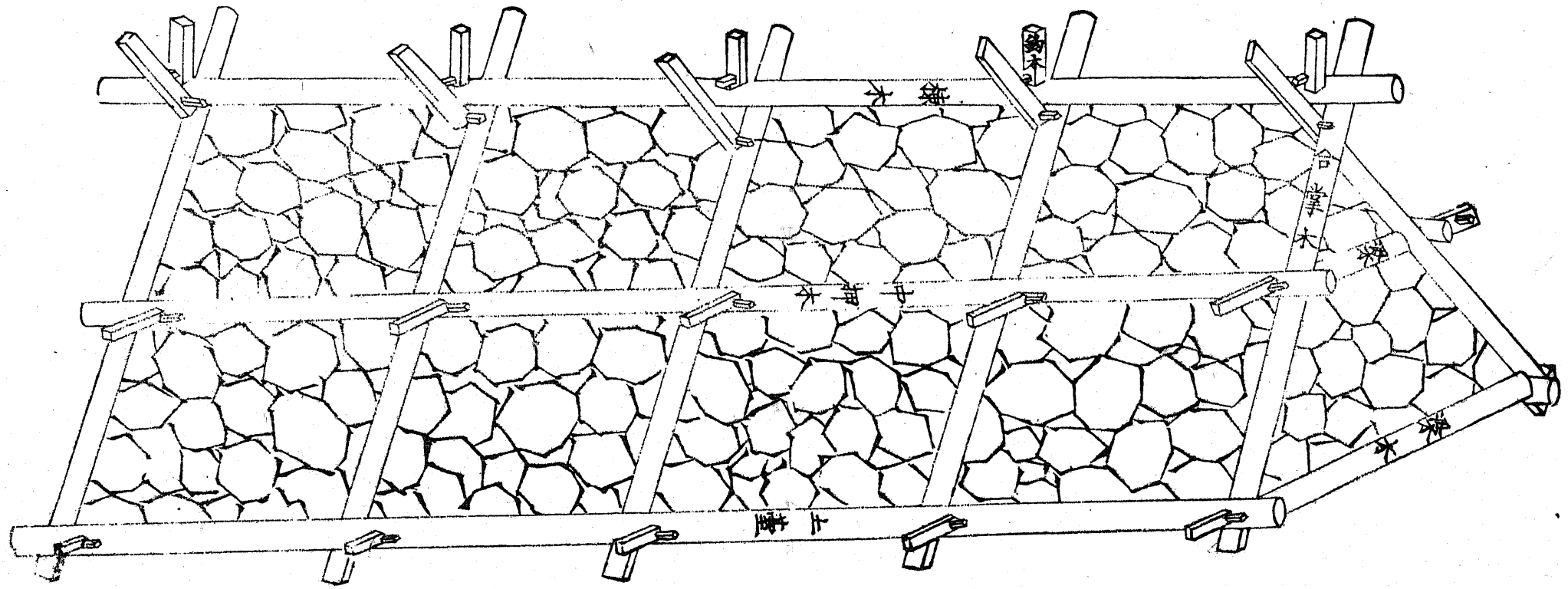

沉枋之圖

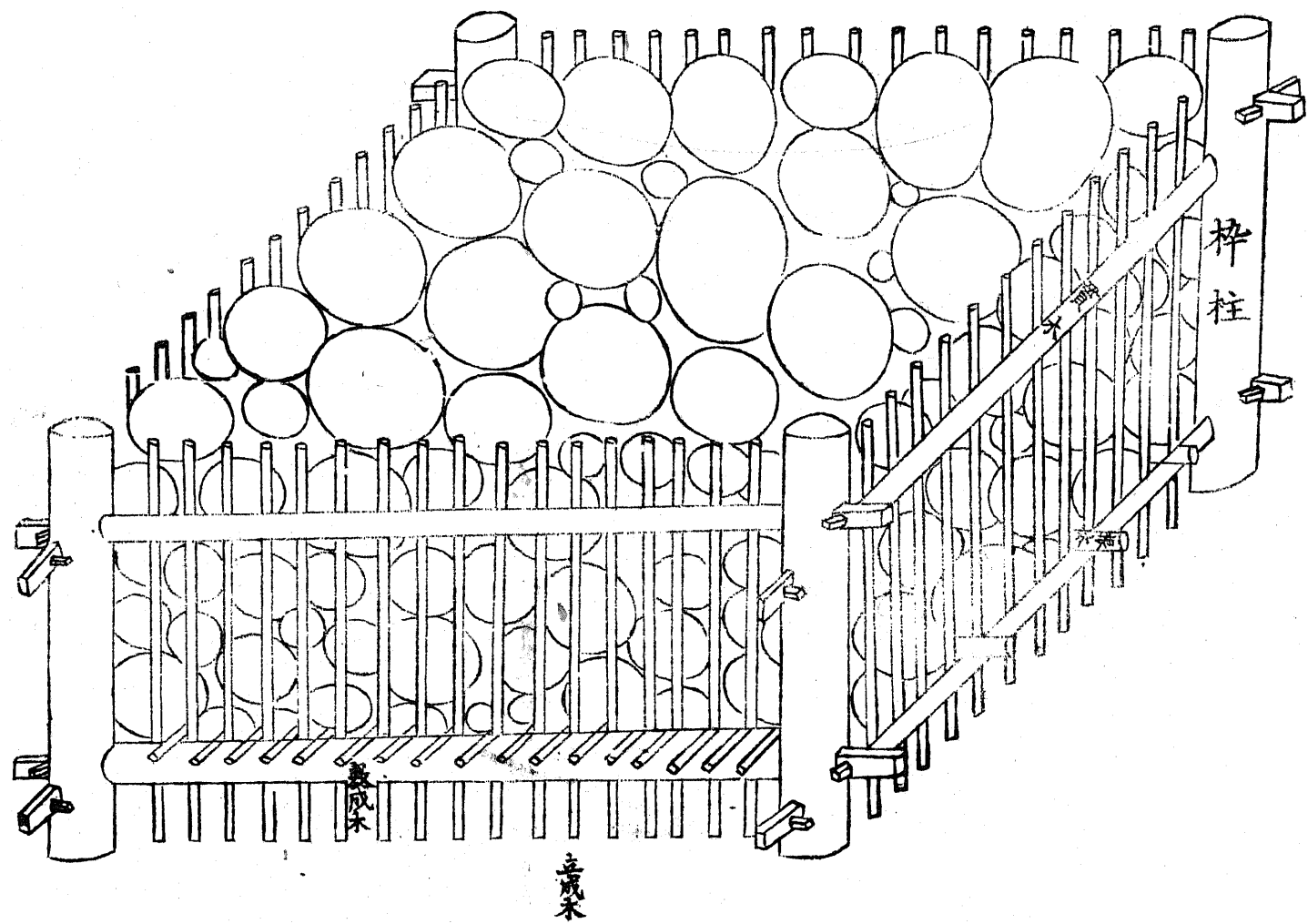

辨慶梓之圖

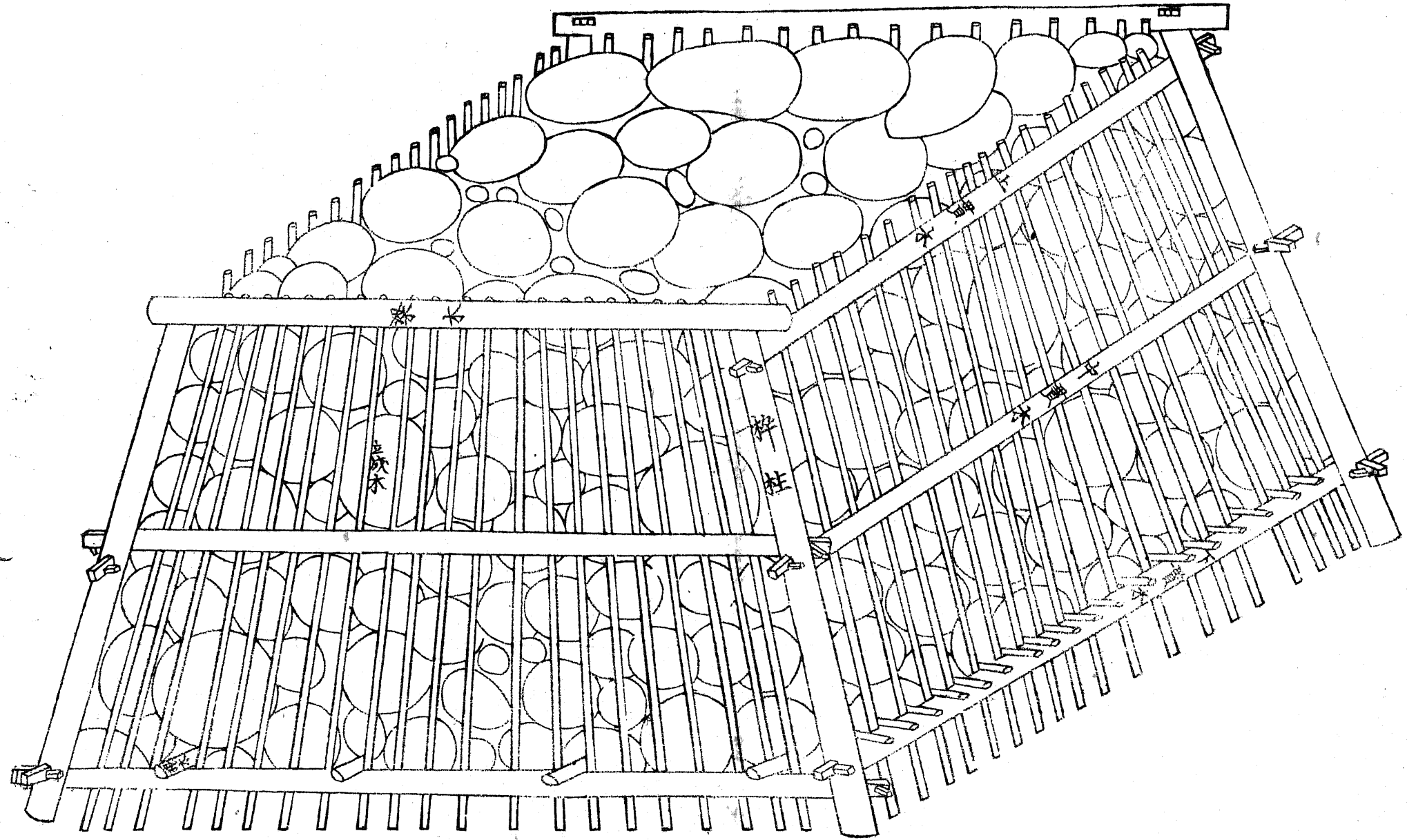

續梓之圖

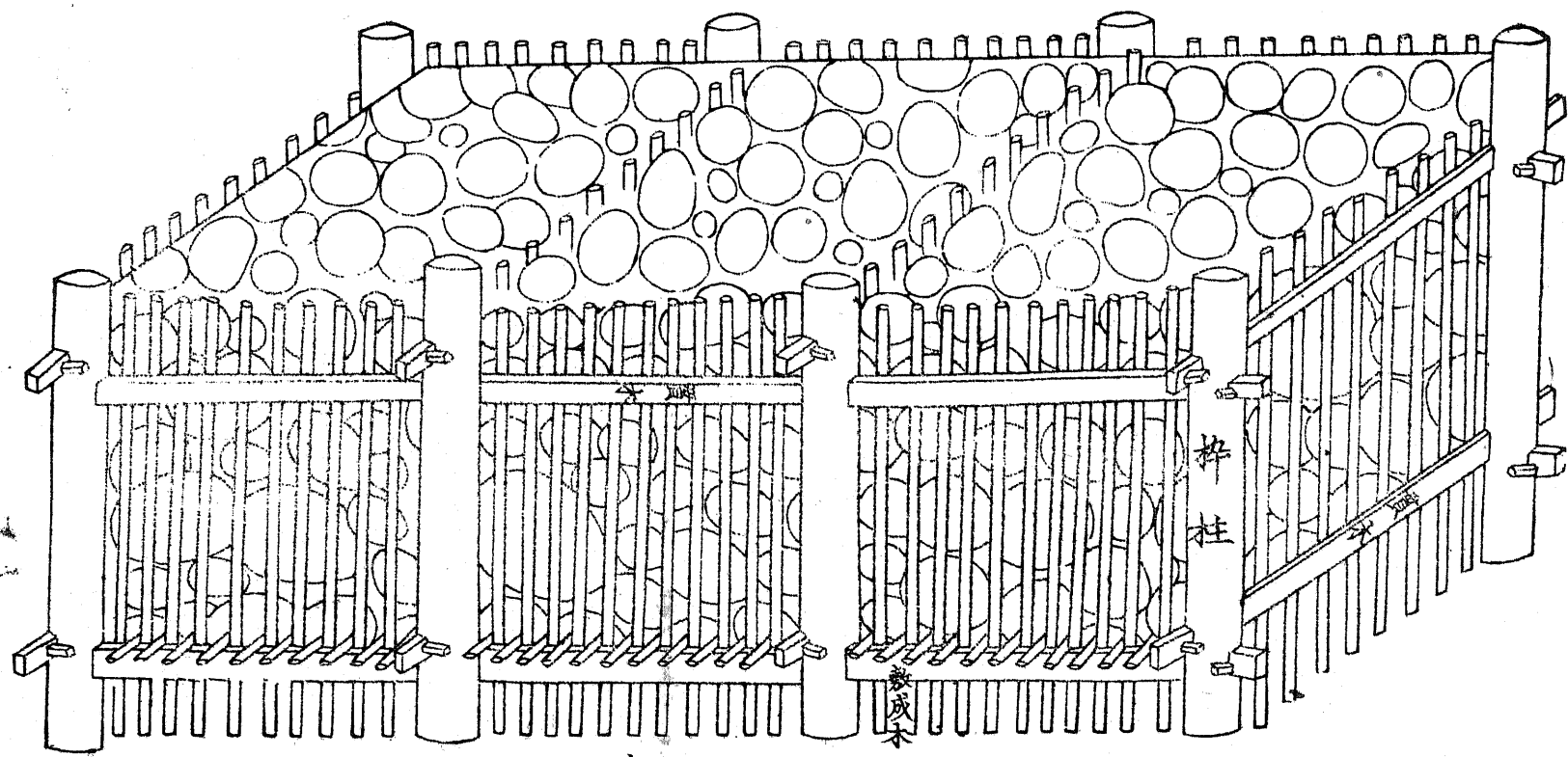

立成木

梓柱

發成木

片枰之圖

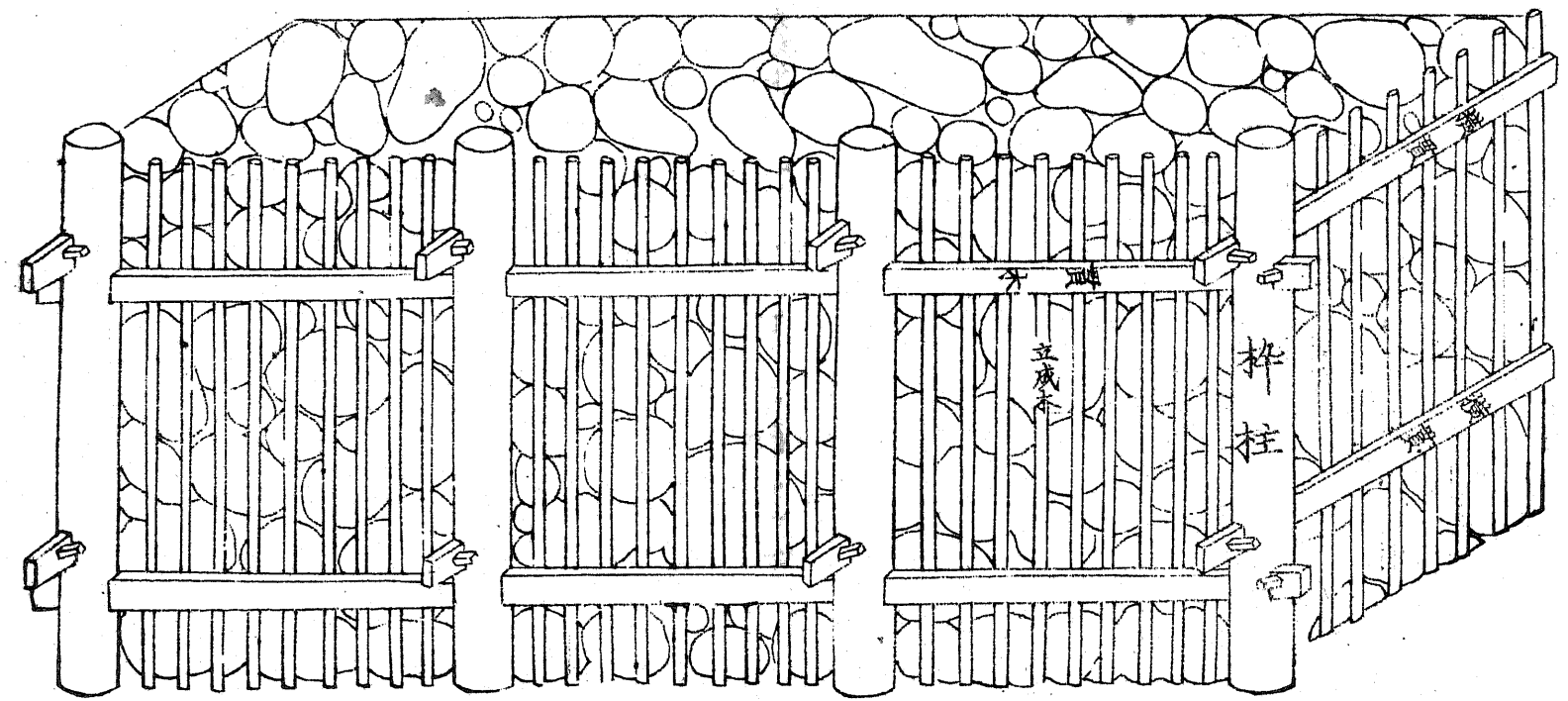

2

楸梓之図

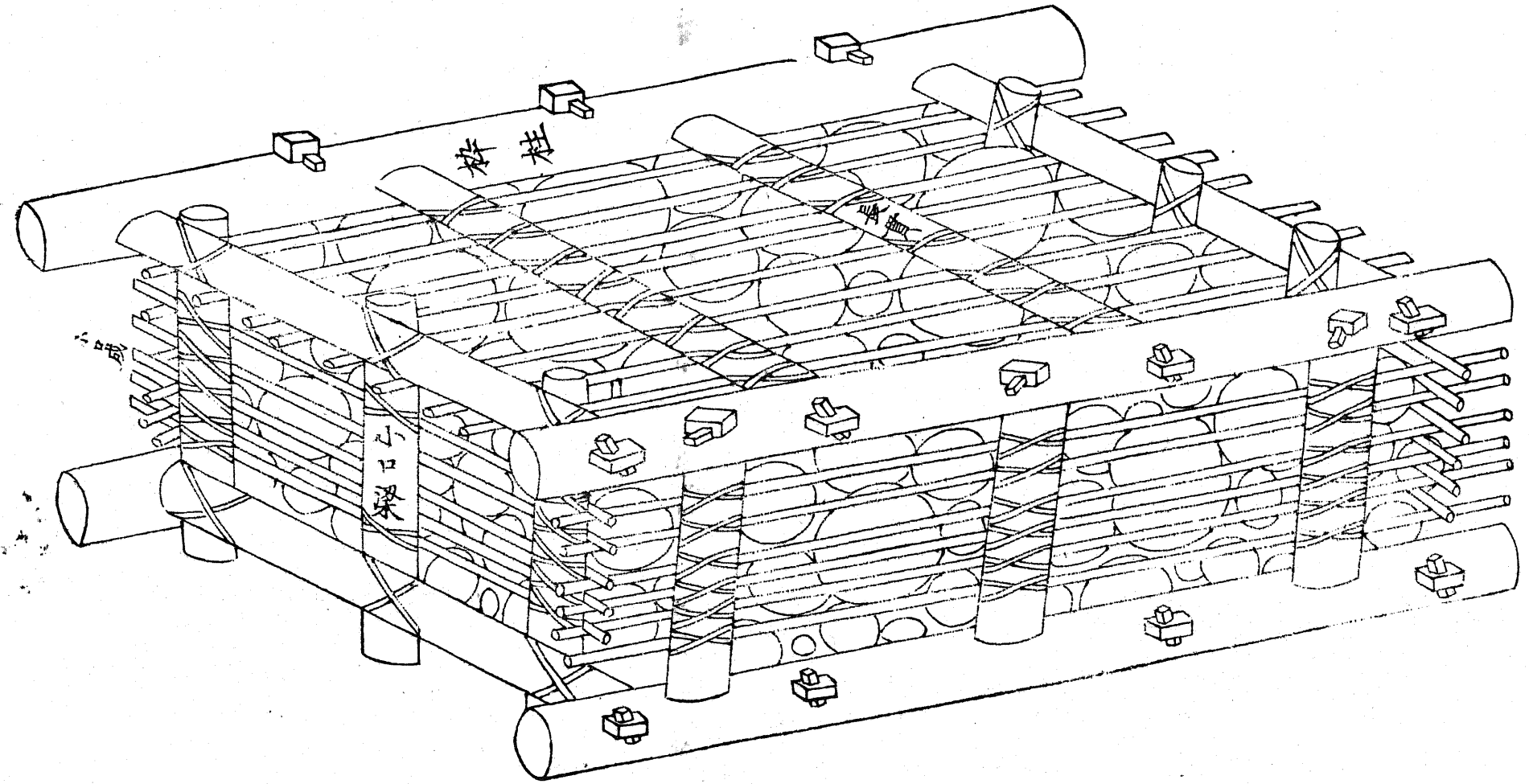

粹出之圖

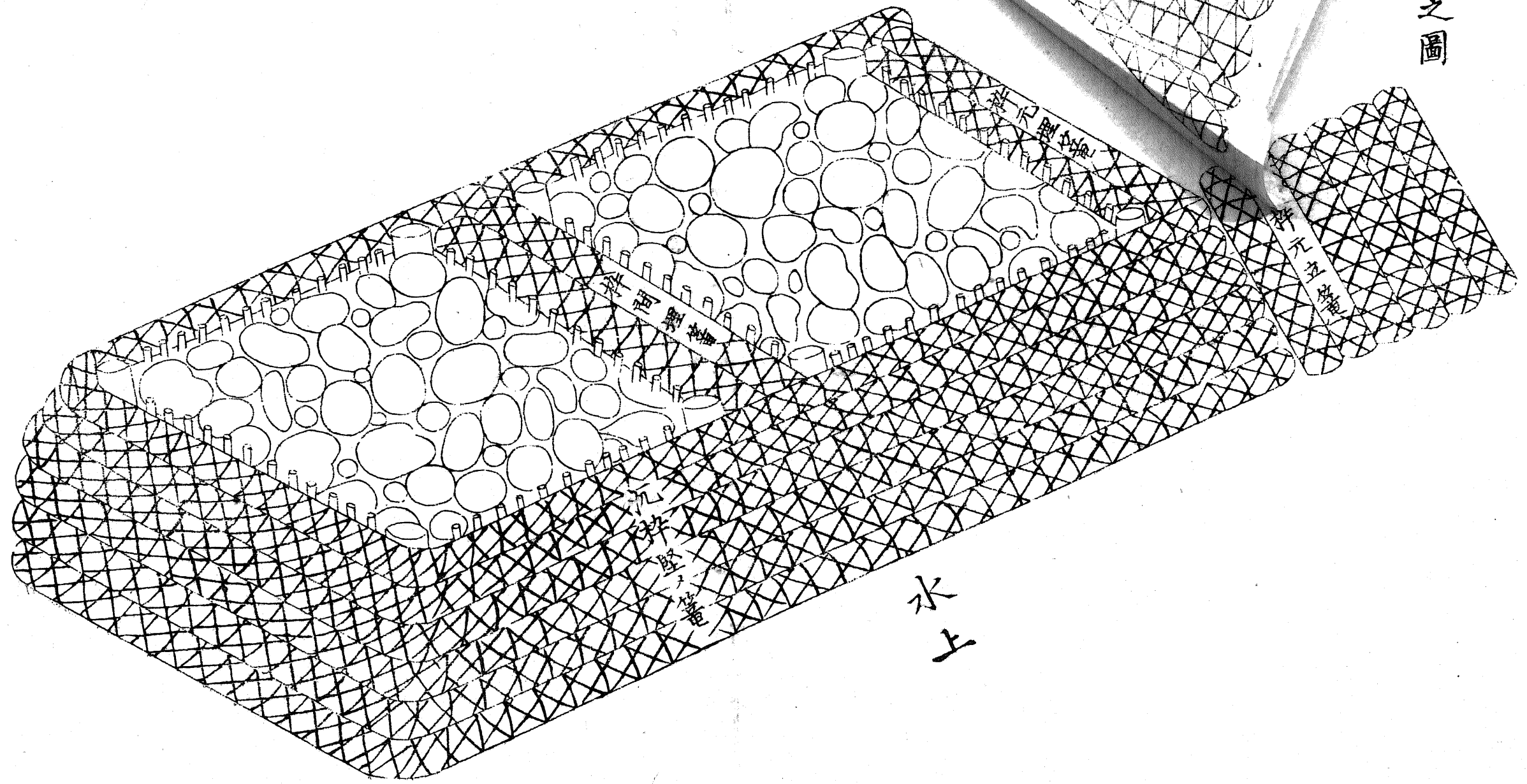

水
上

間

元五

粹出之圖

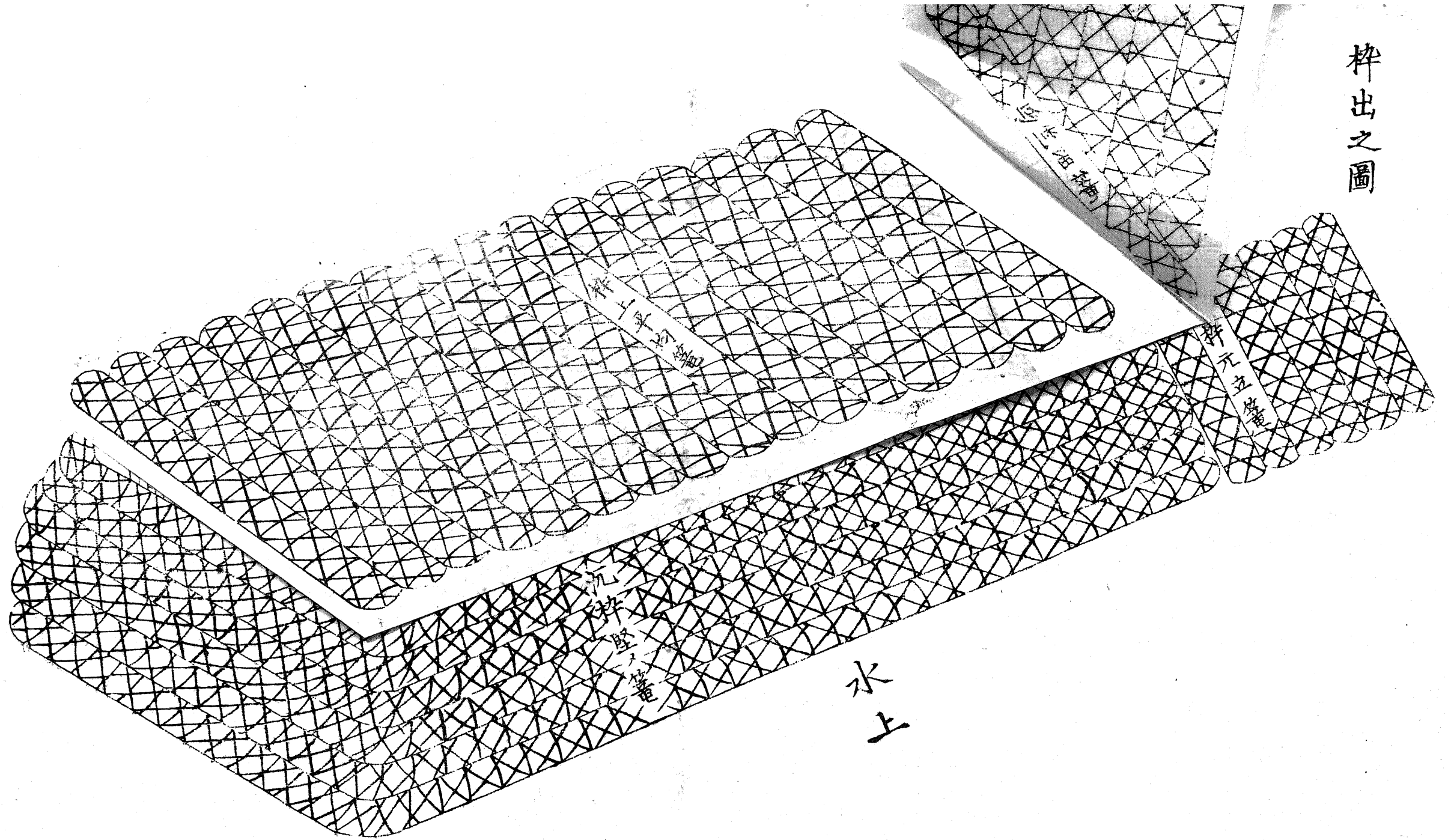

水上

榨出之圖

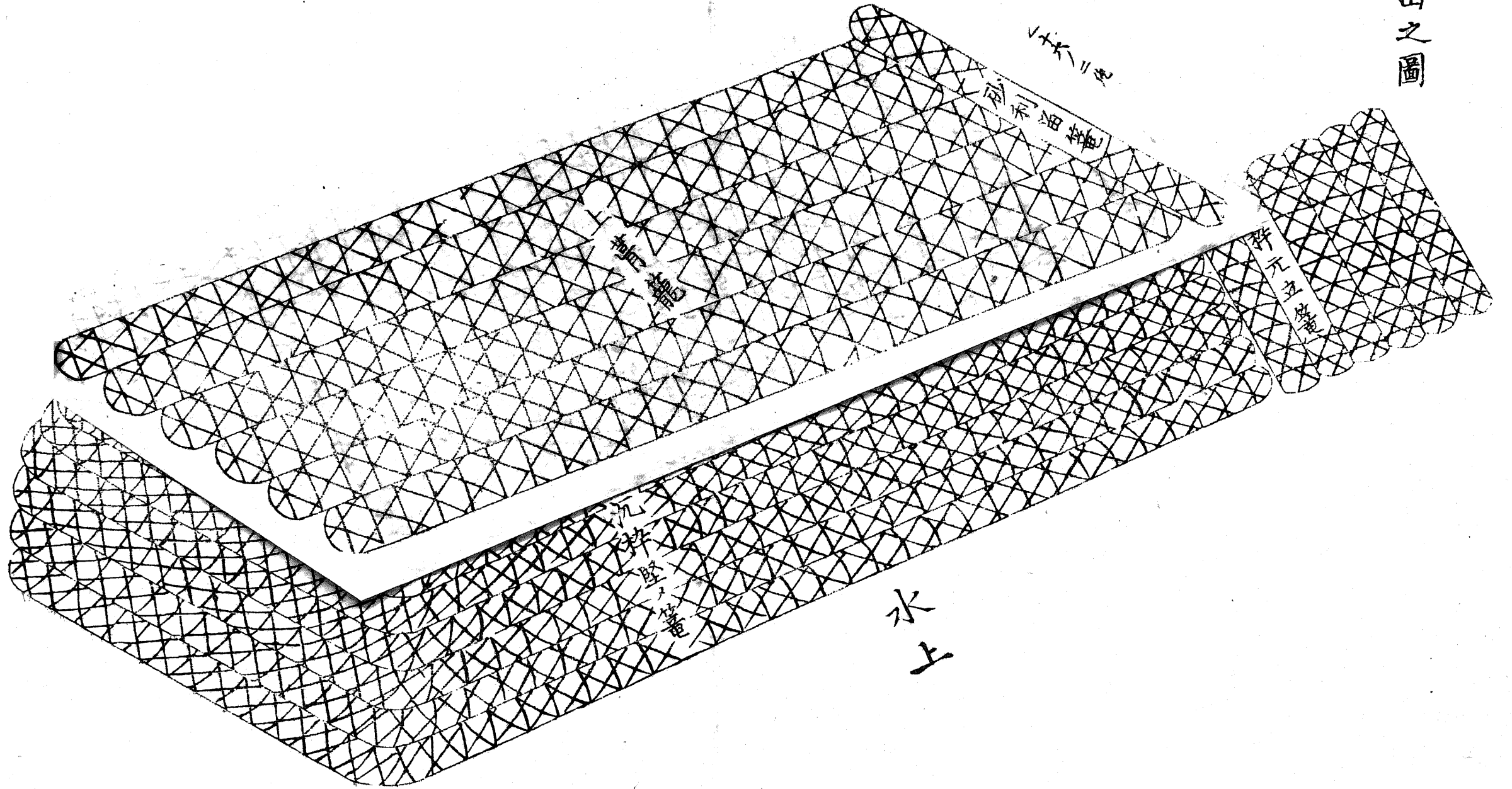

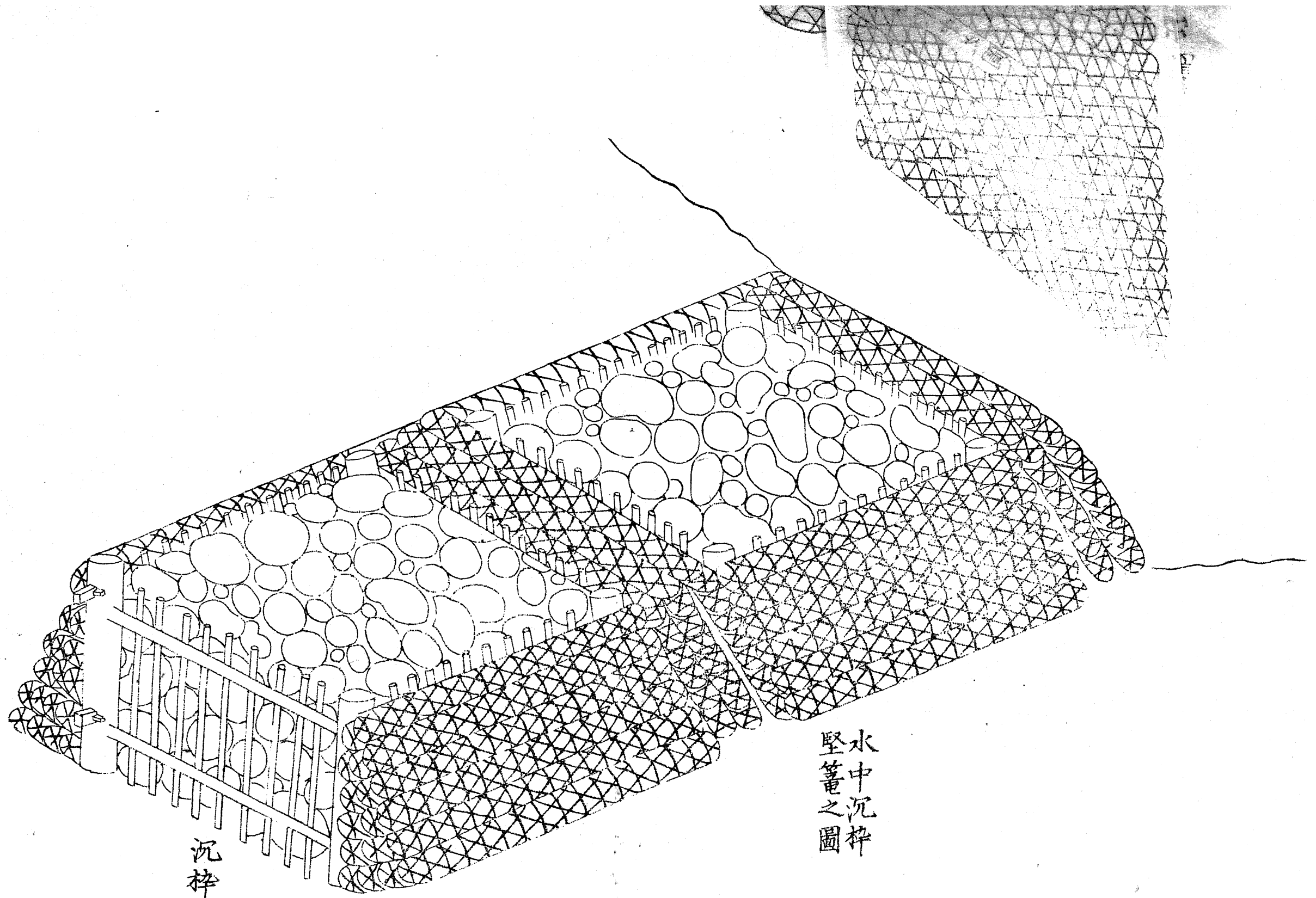

沉梓

水中沉梓
堅篋之圖

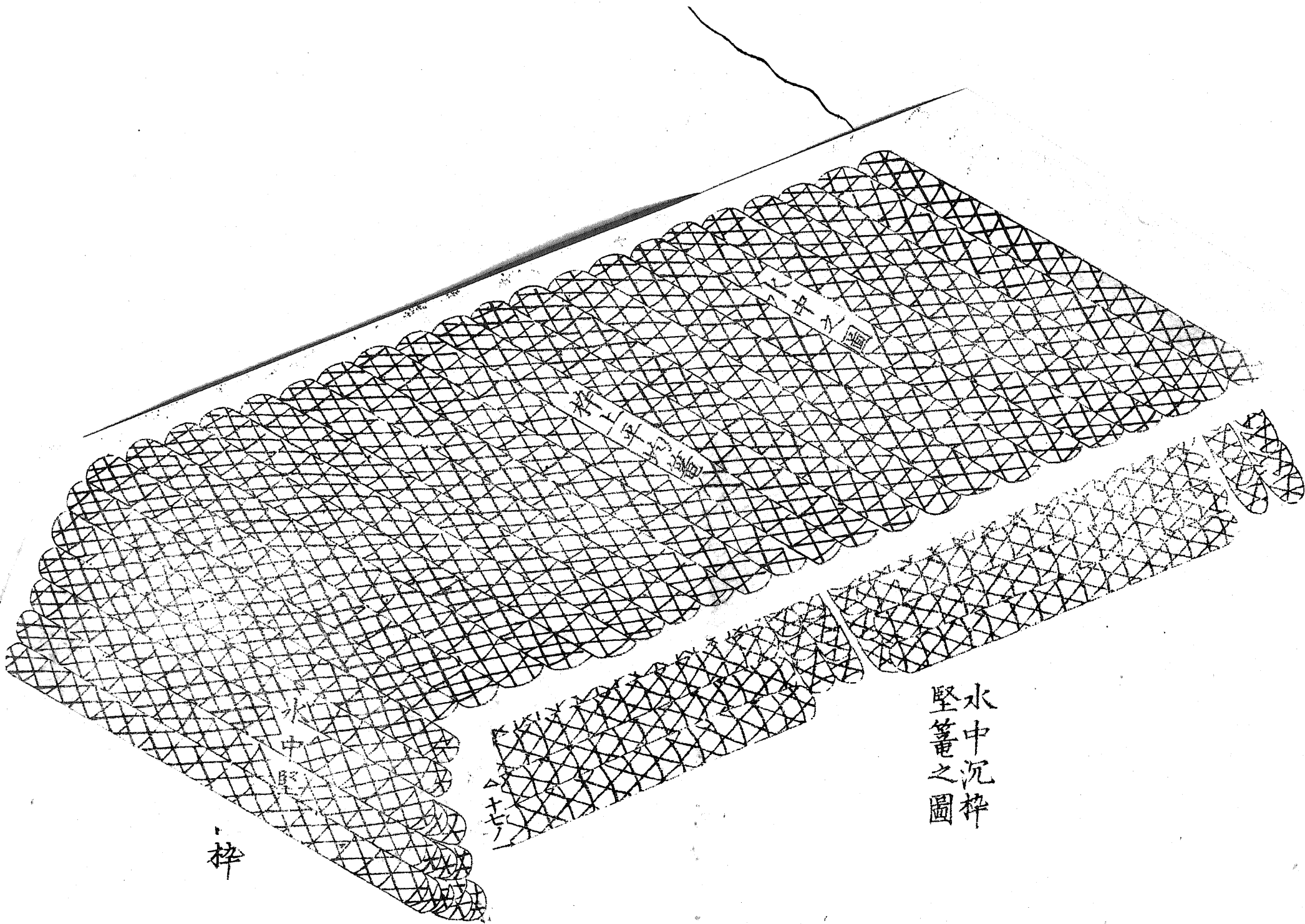

水中沉梓
堅篋之圖

梓

十方

十方

十方

十方

籠出之圖

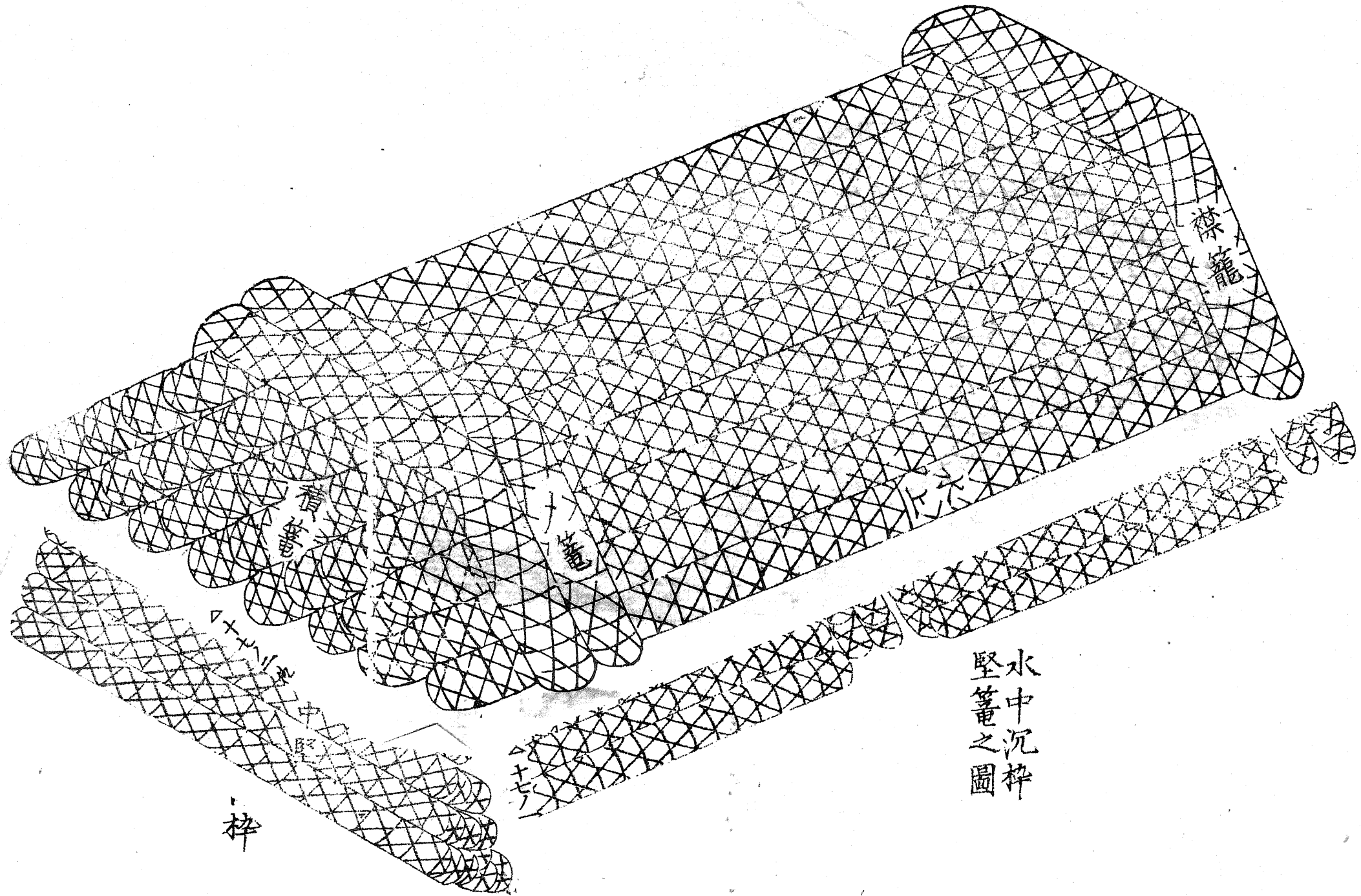

水中沉棹
堅籠之圖

棹

腹籠之圖

腹籠

梅條

梅條

形籠

立籠之圖

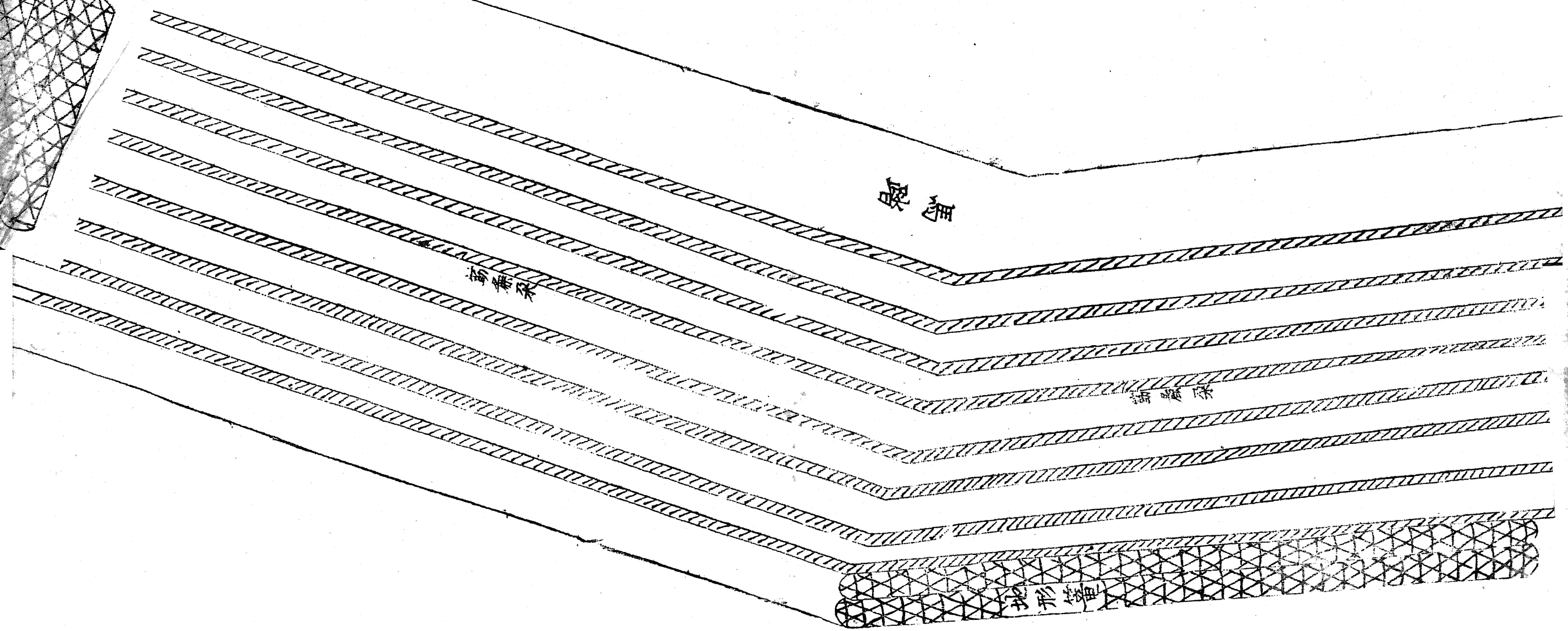
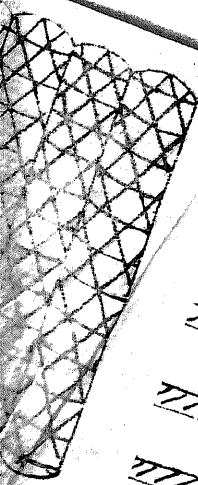

腹籠之圖

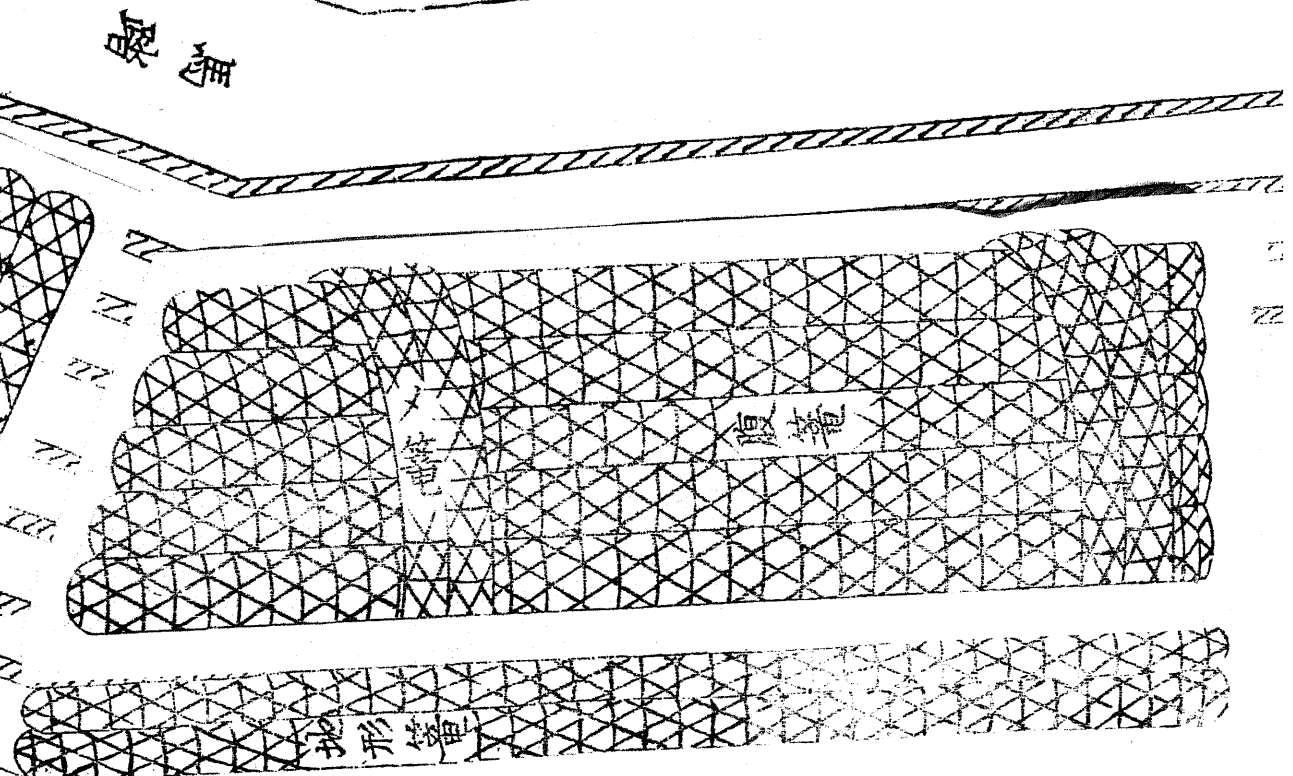

立籠之圖

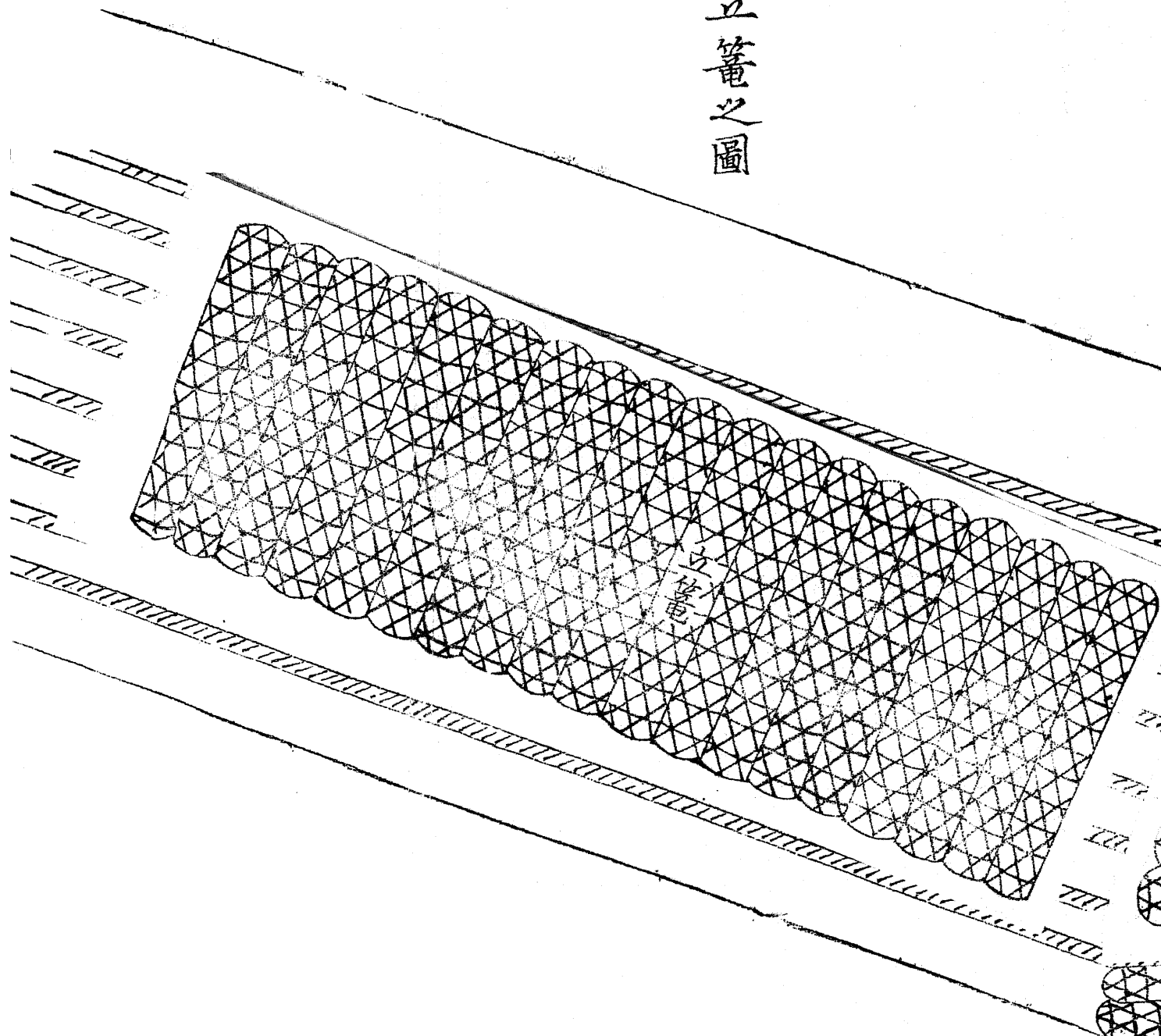

圖

地形籠

腹籠

立籠

籠洗之圖

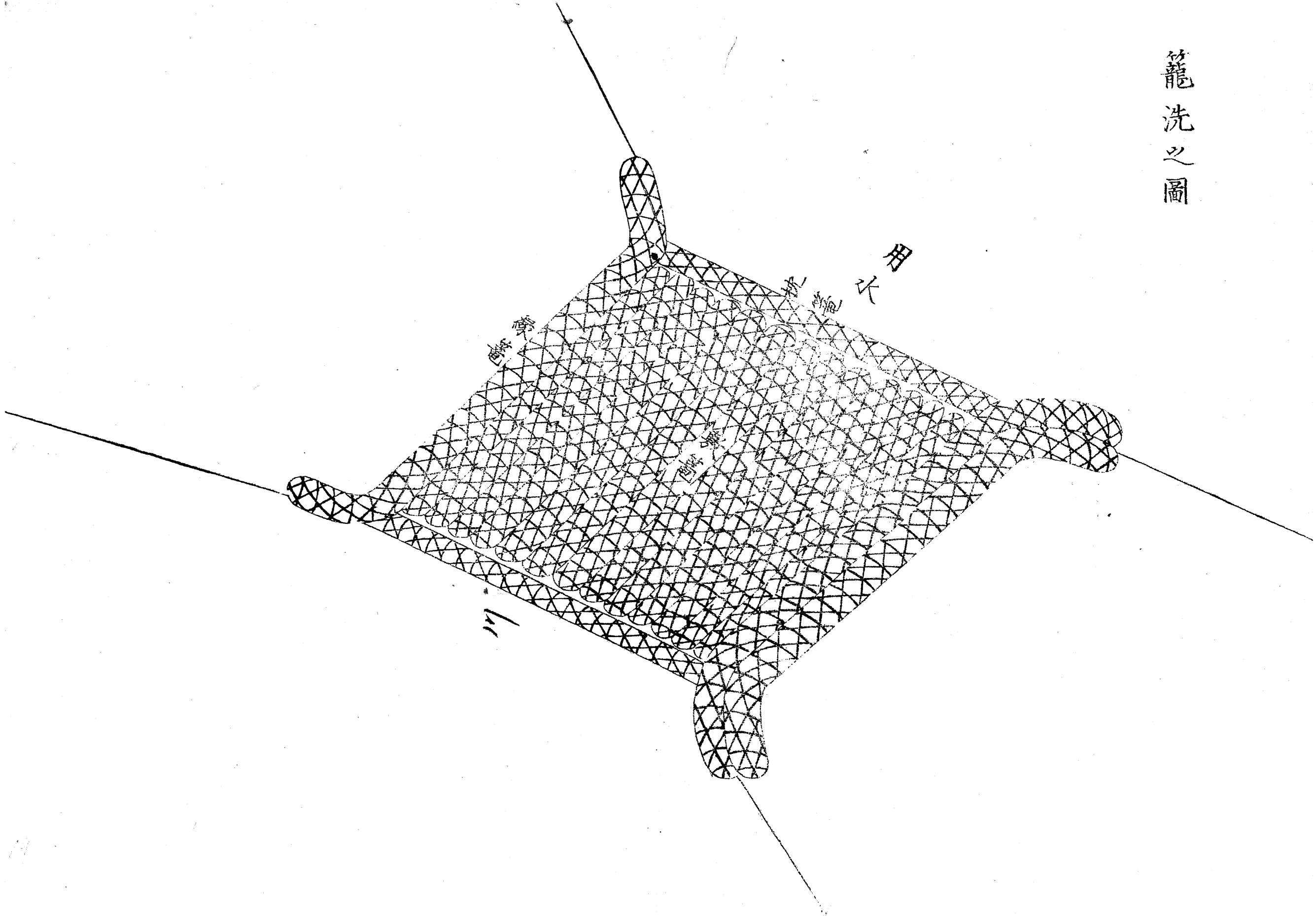

萱羽口
土出
之圖

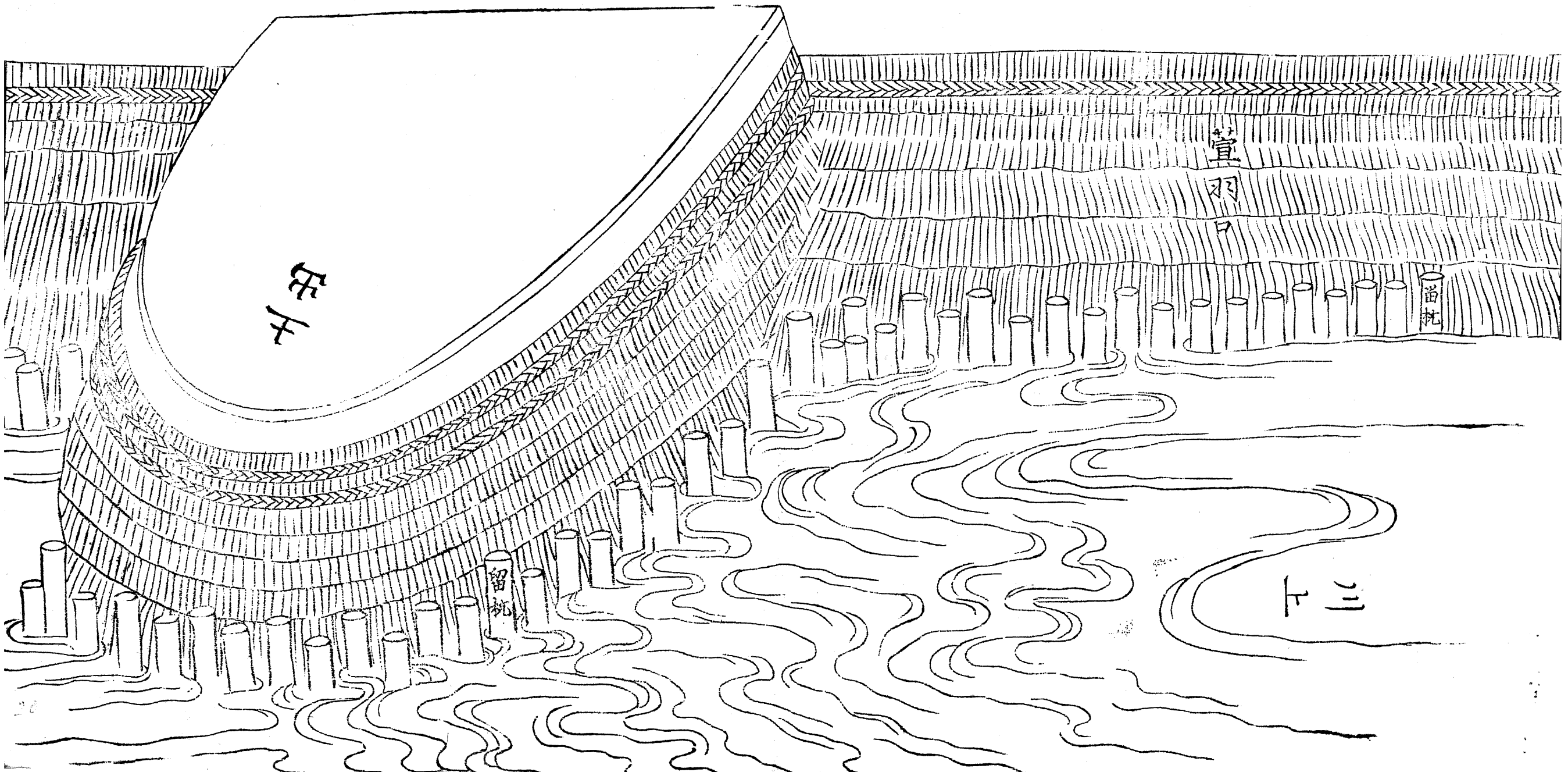

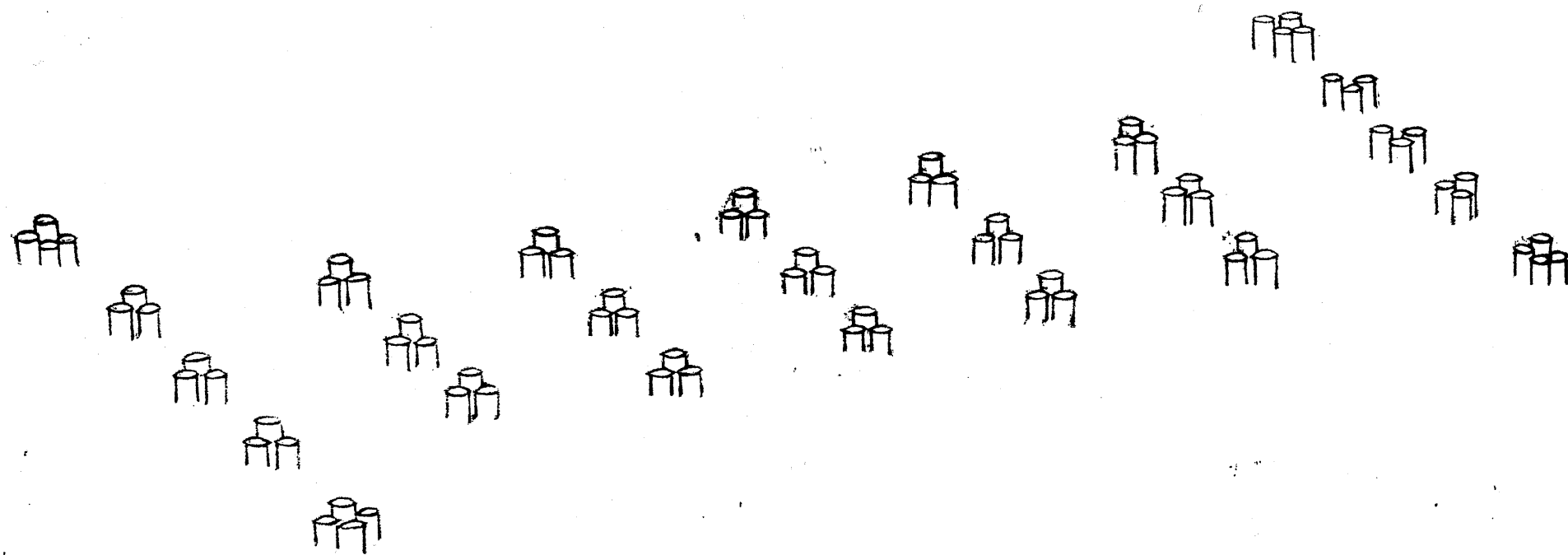

土臺組之圖

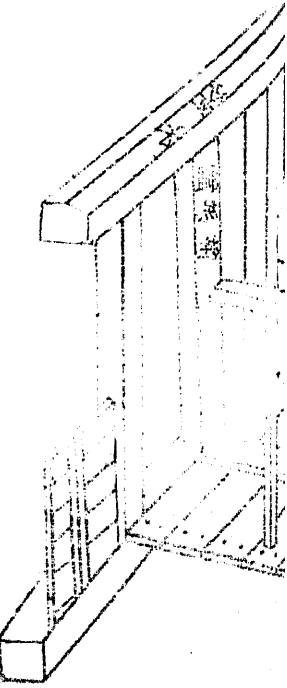
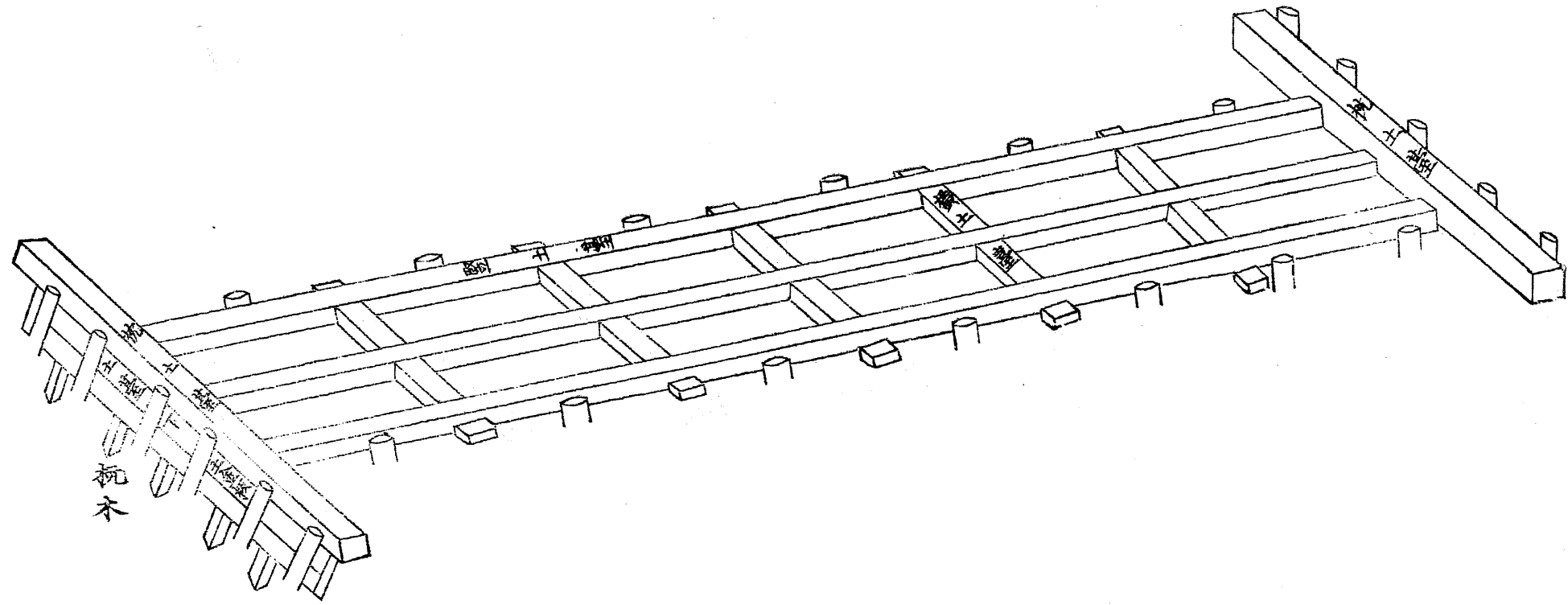

土臺

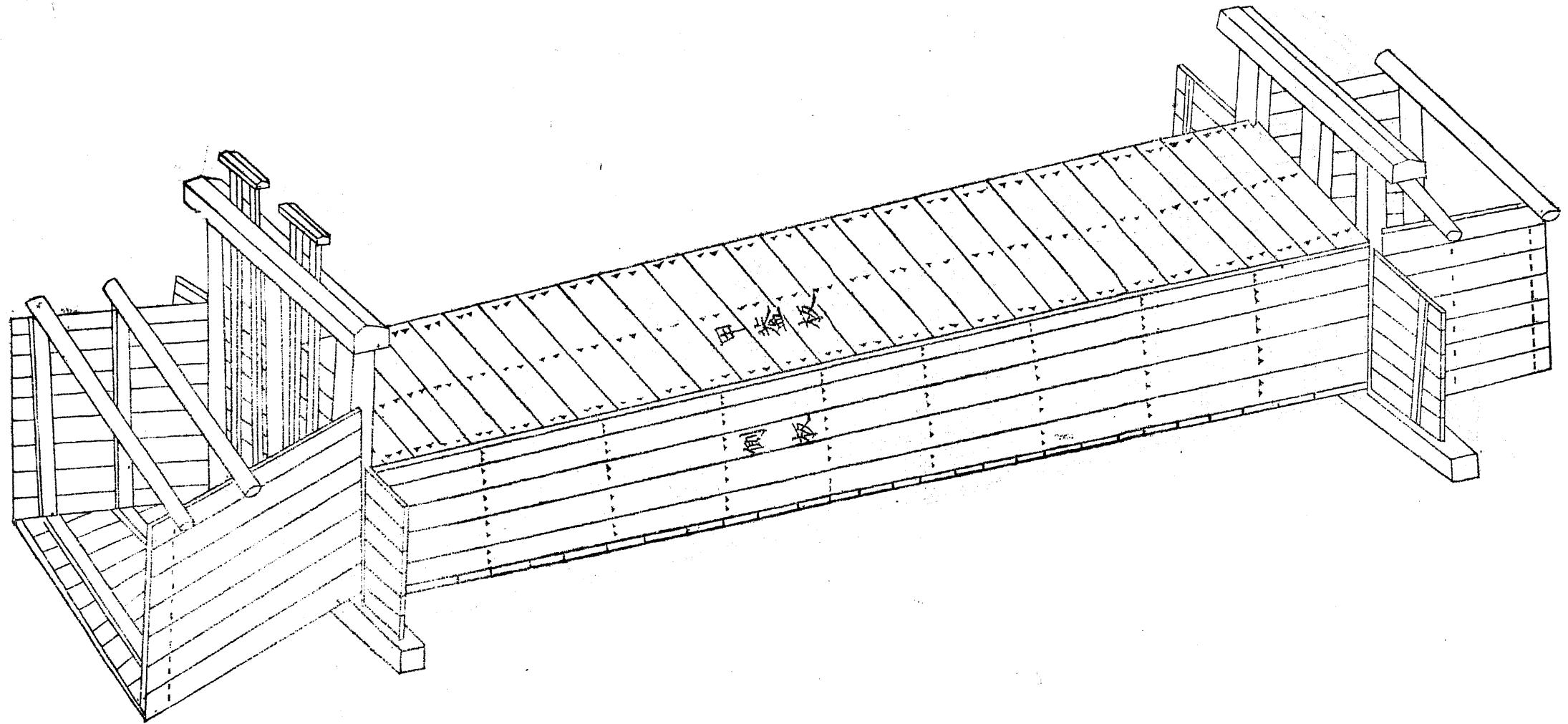

紀州流入樋之圖

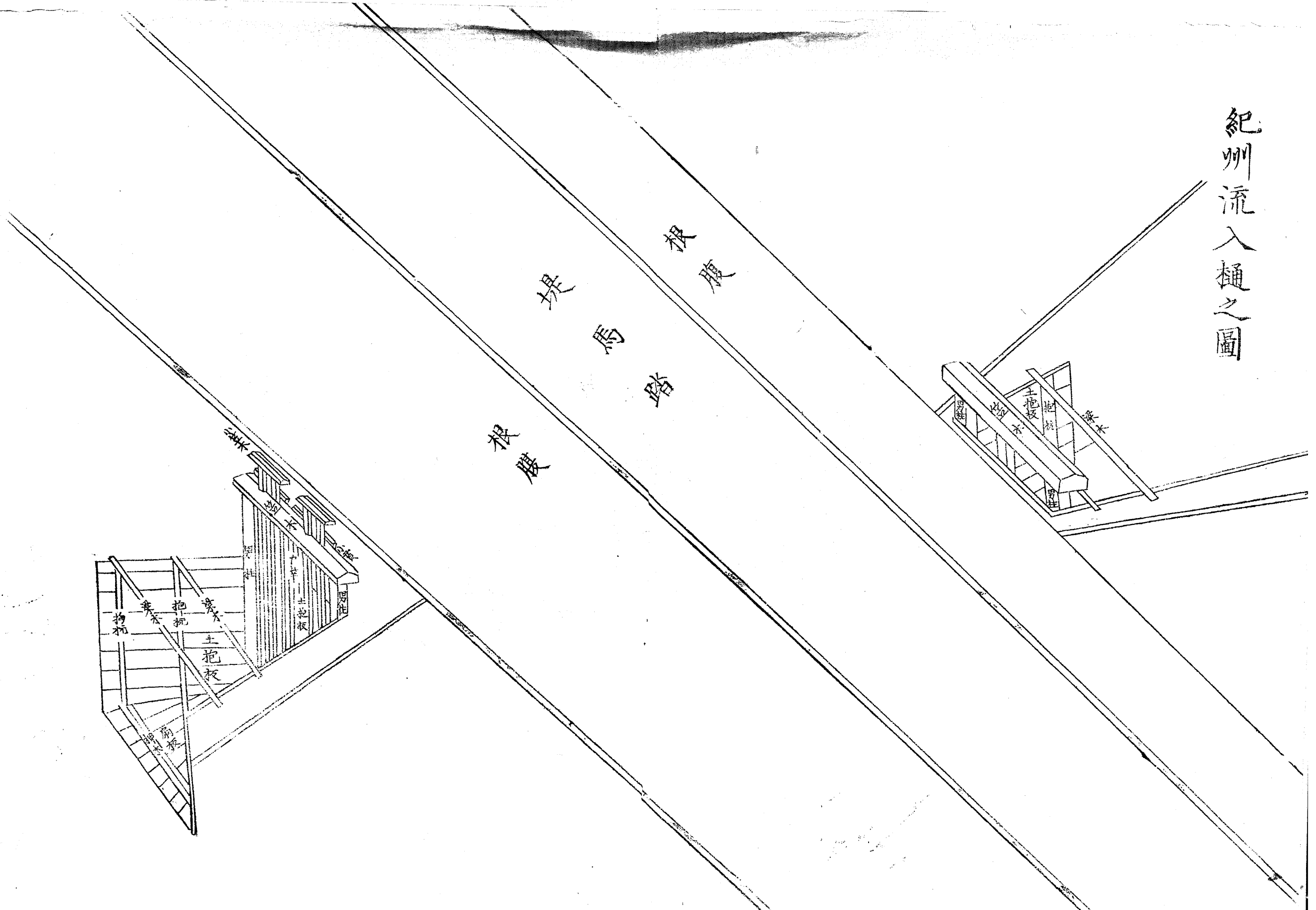

門法組方之圖

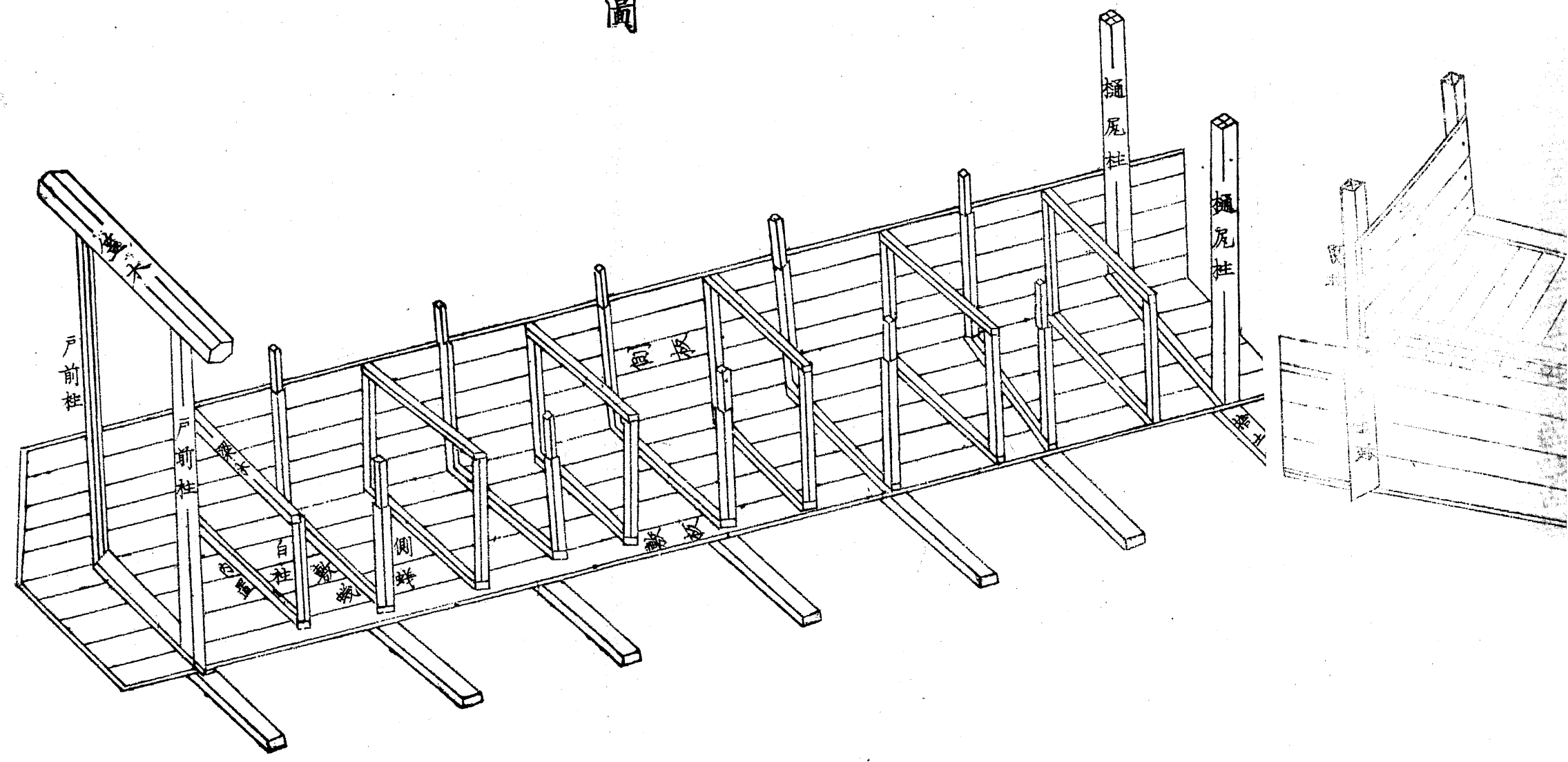

方之組法

方之立組

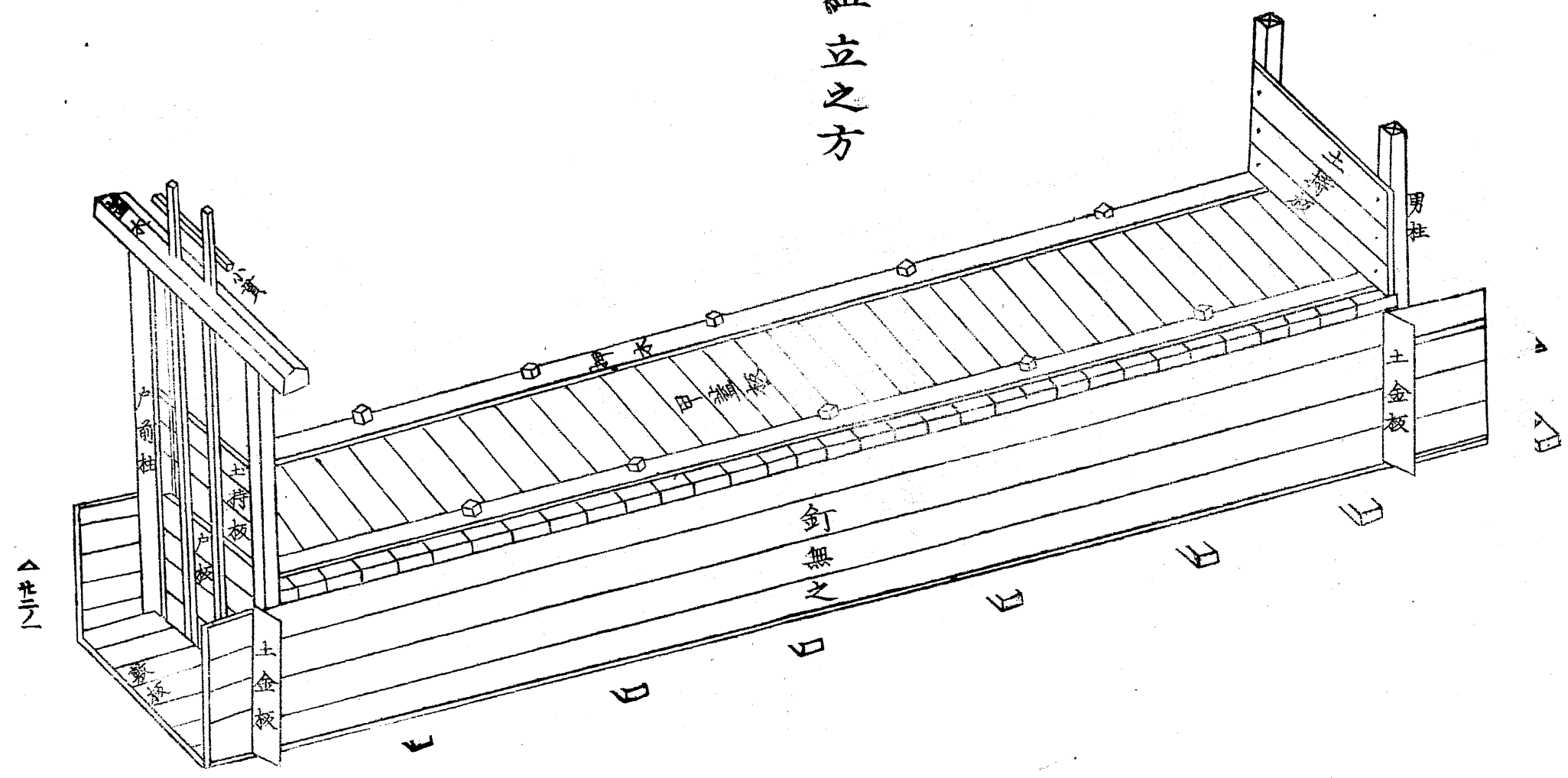

關東流以樋之圖

樋尻之方

樋腹

馬踏

樋頭

樋表之方

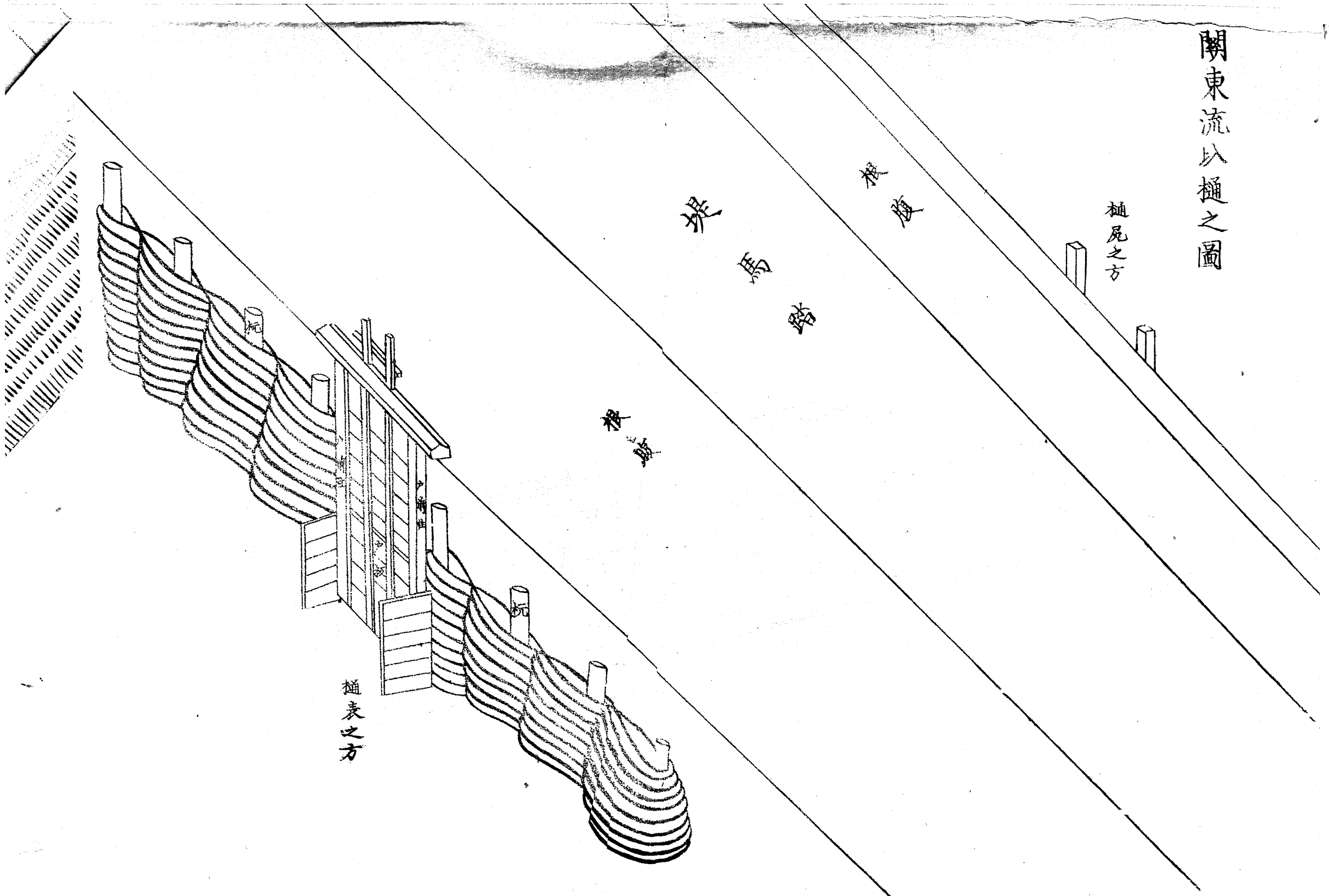

關東流以樋之圖

植屍之方

板腹

馬踏

板腹

方之方

欄板

欄板

公事

欄板

欄板

欄板

欄板

置

口

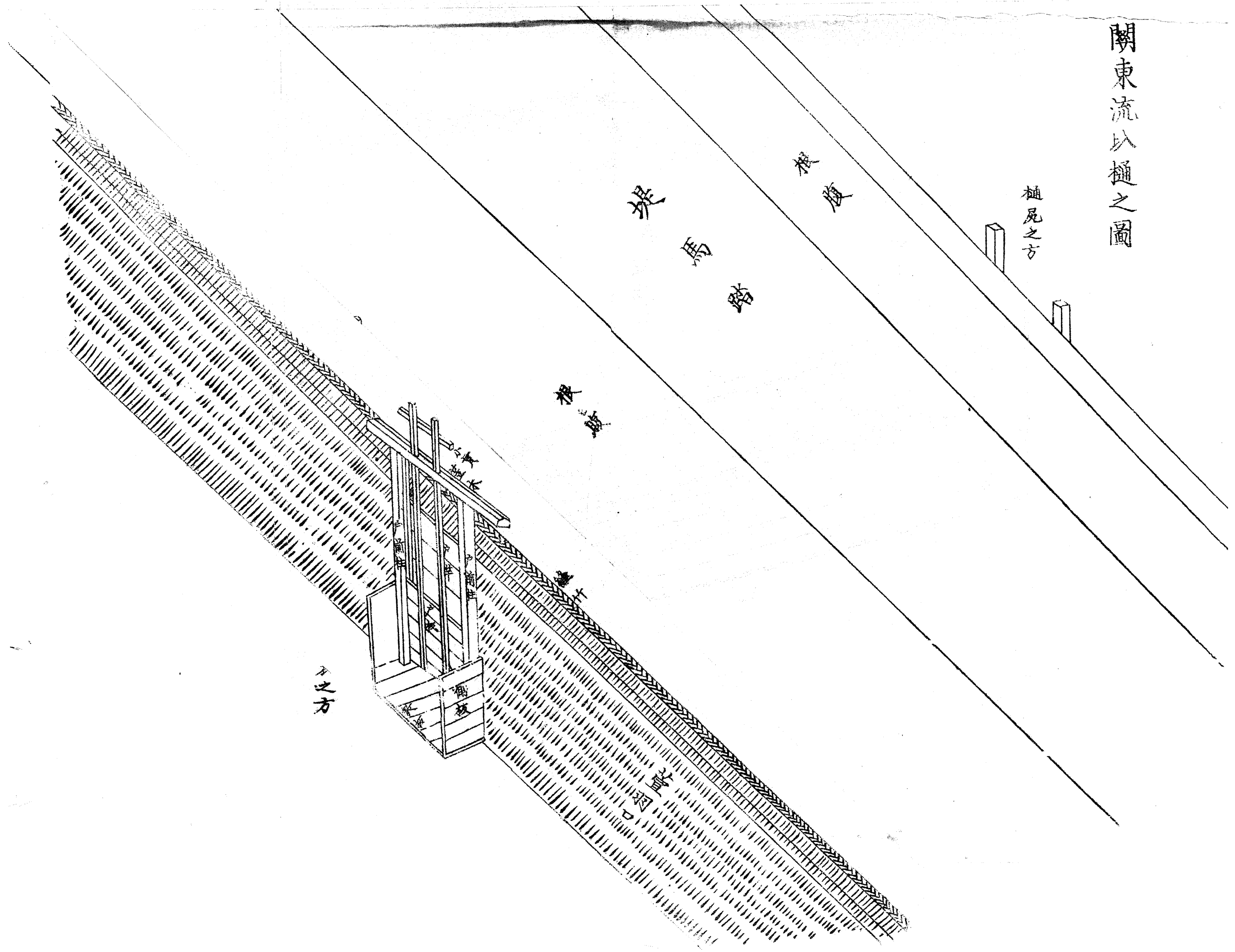

地杭打タル圖

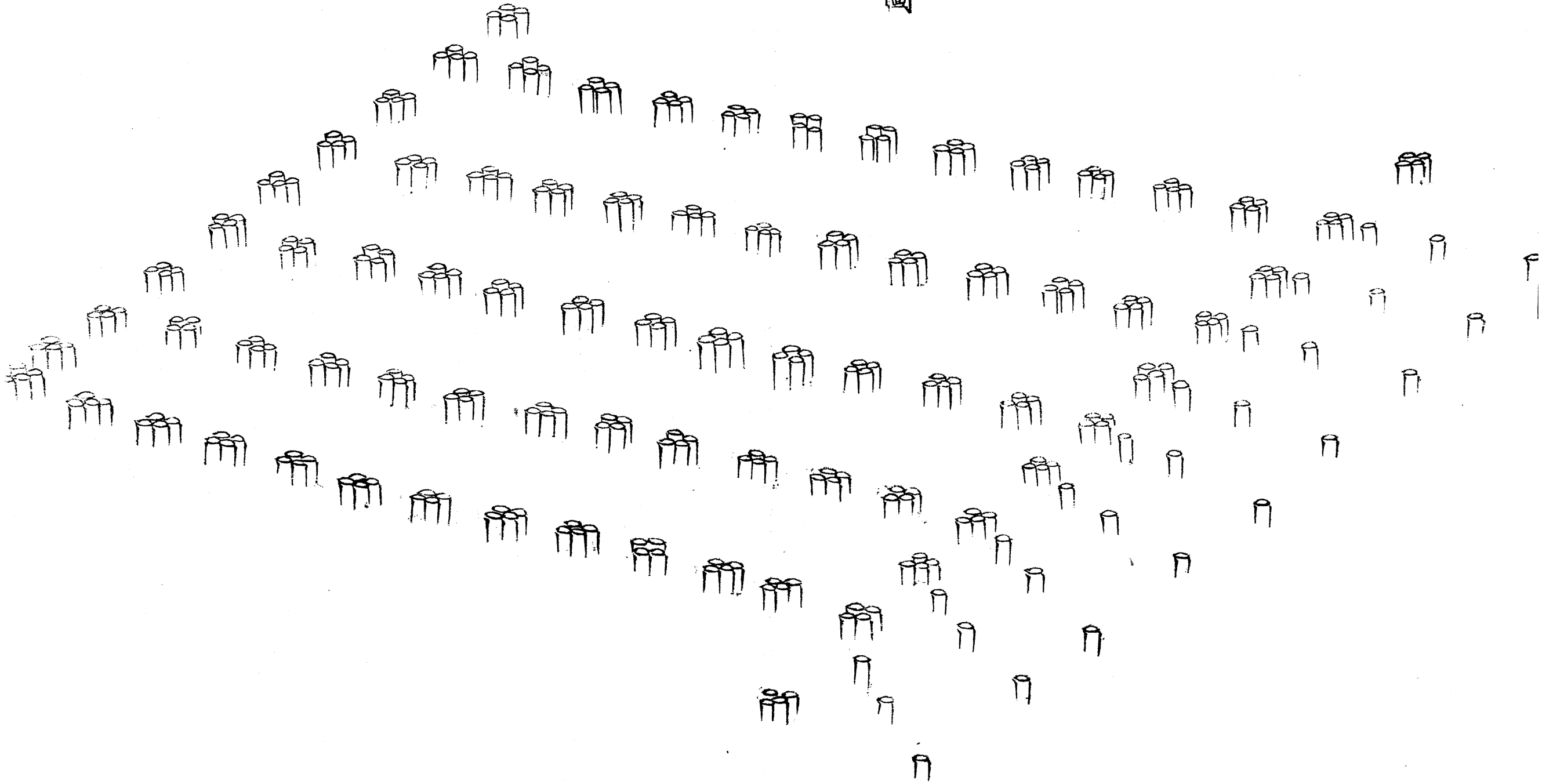

逆水留門桶之圖

換
器
換
腹

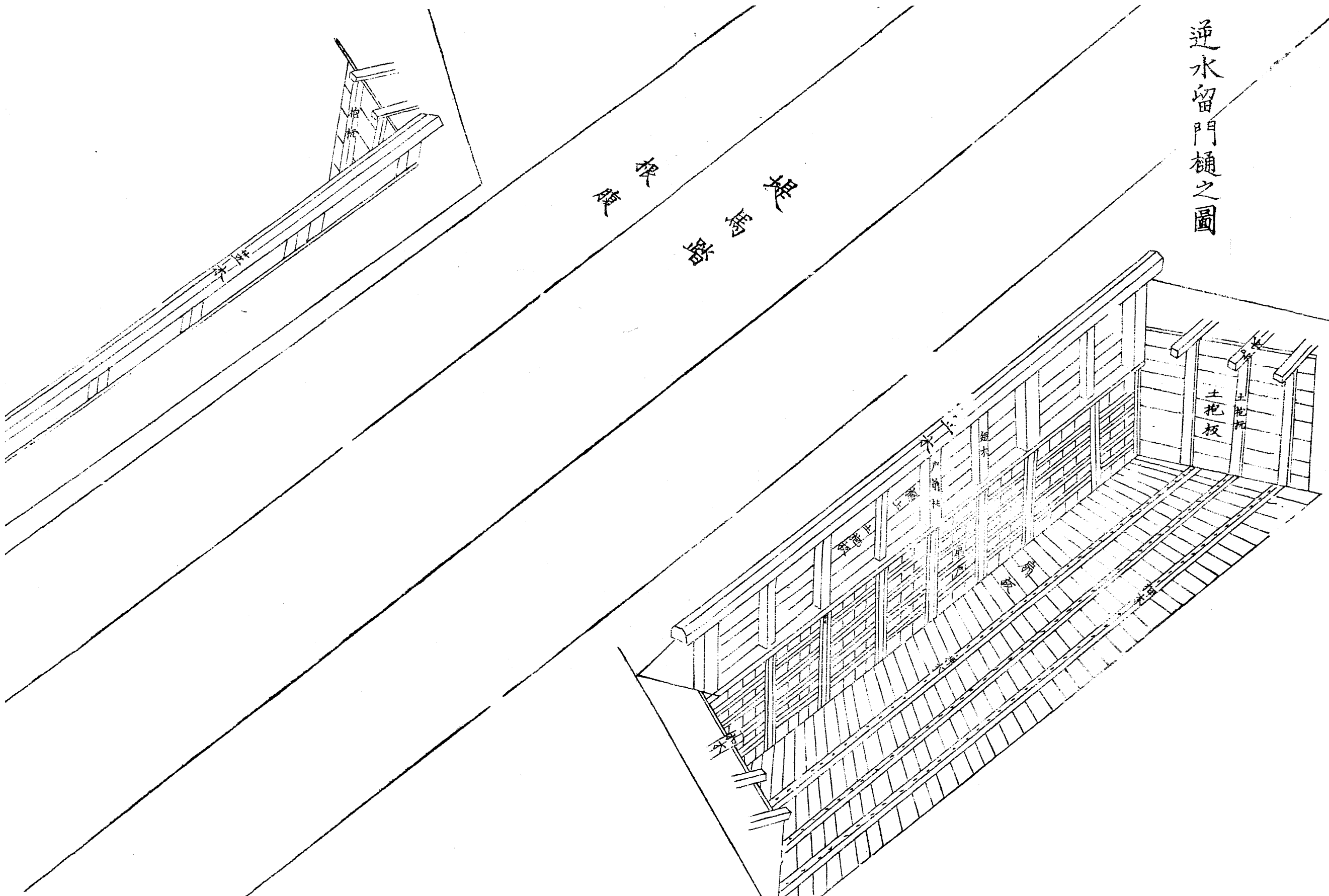

組立之圖

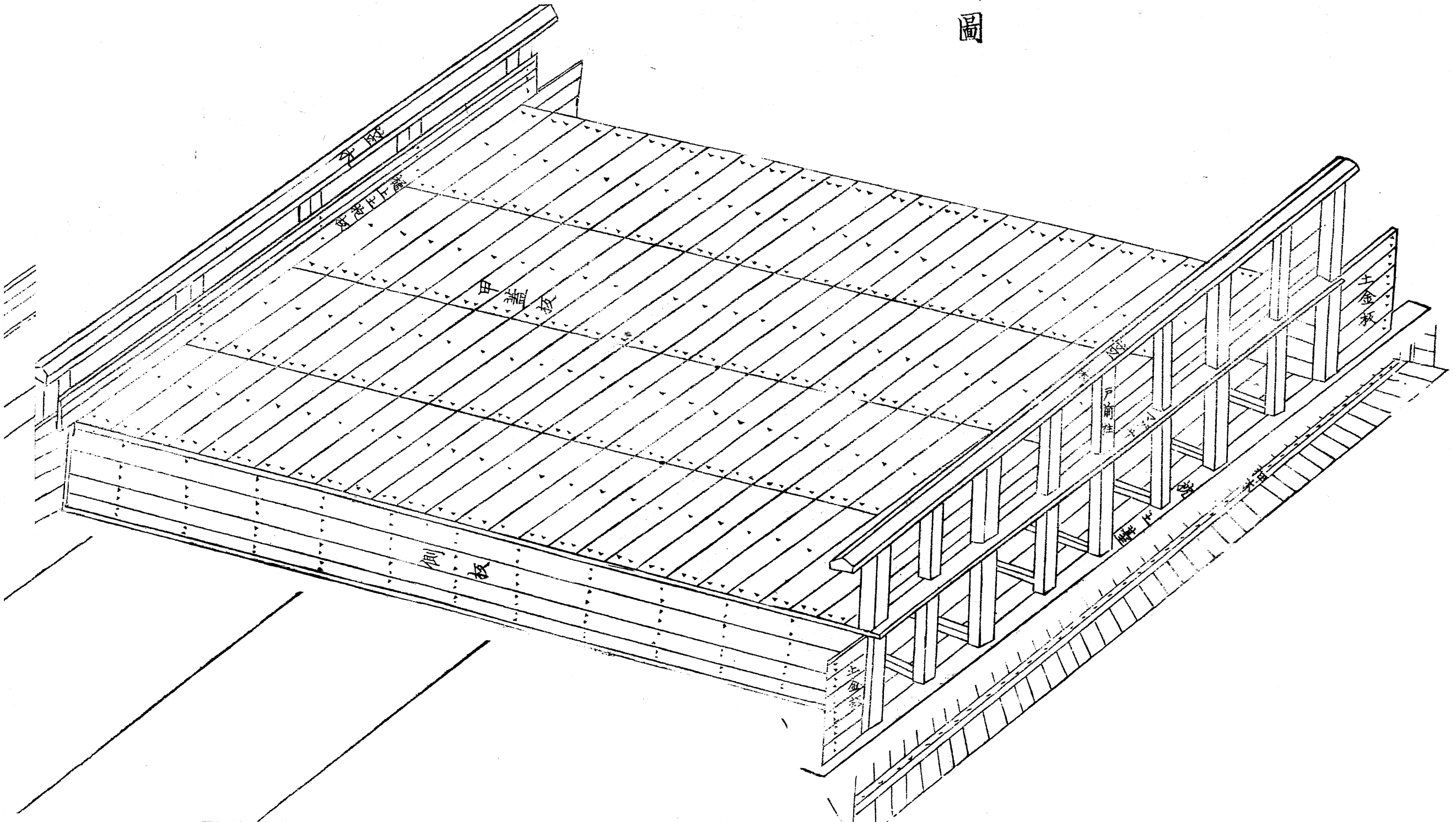

内法組方之圖

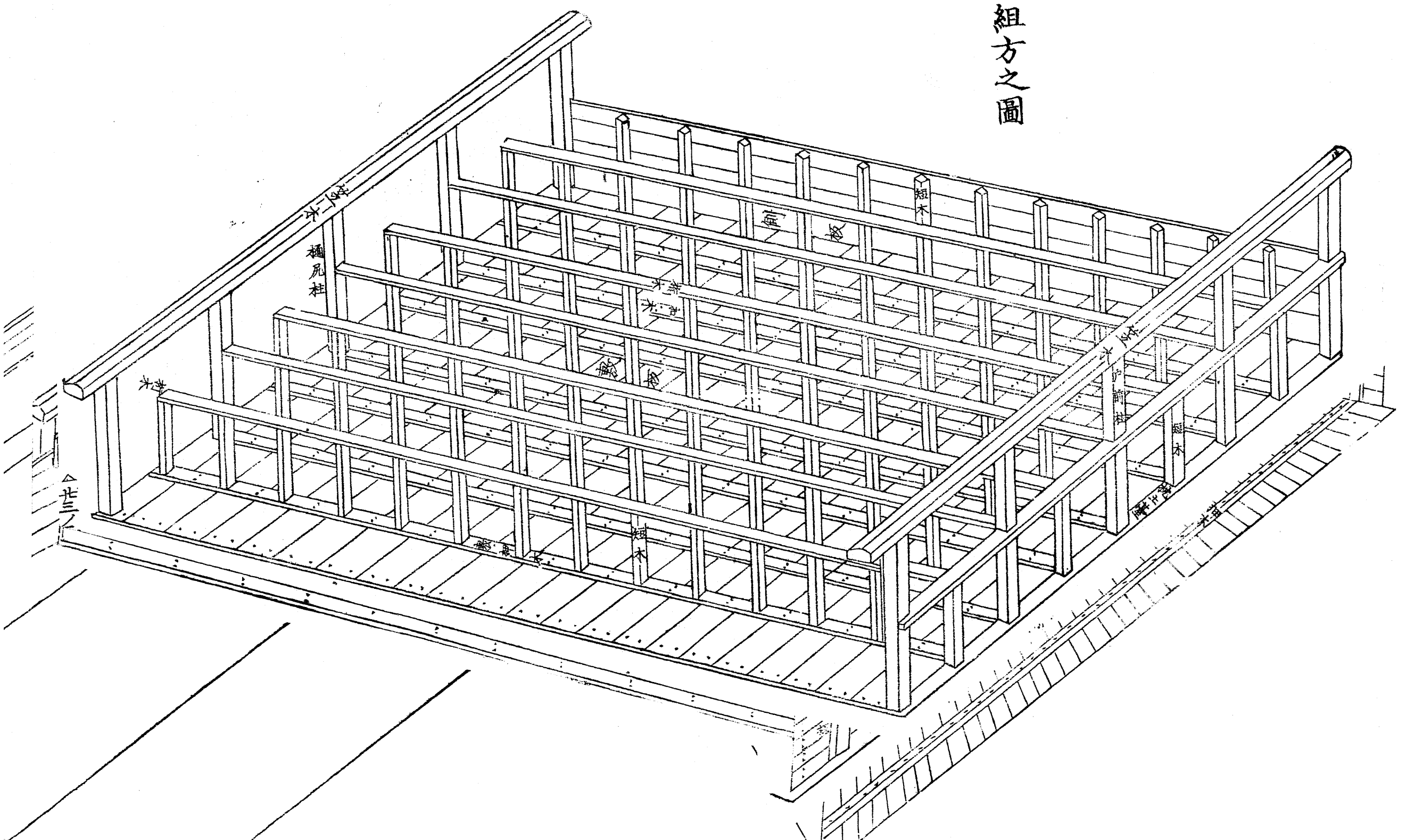

土臺組方之圖

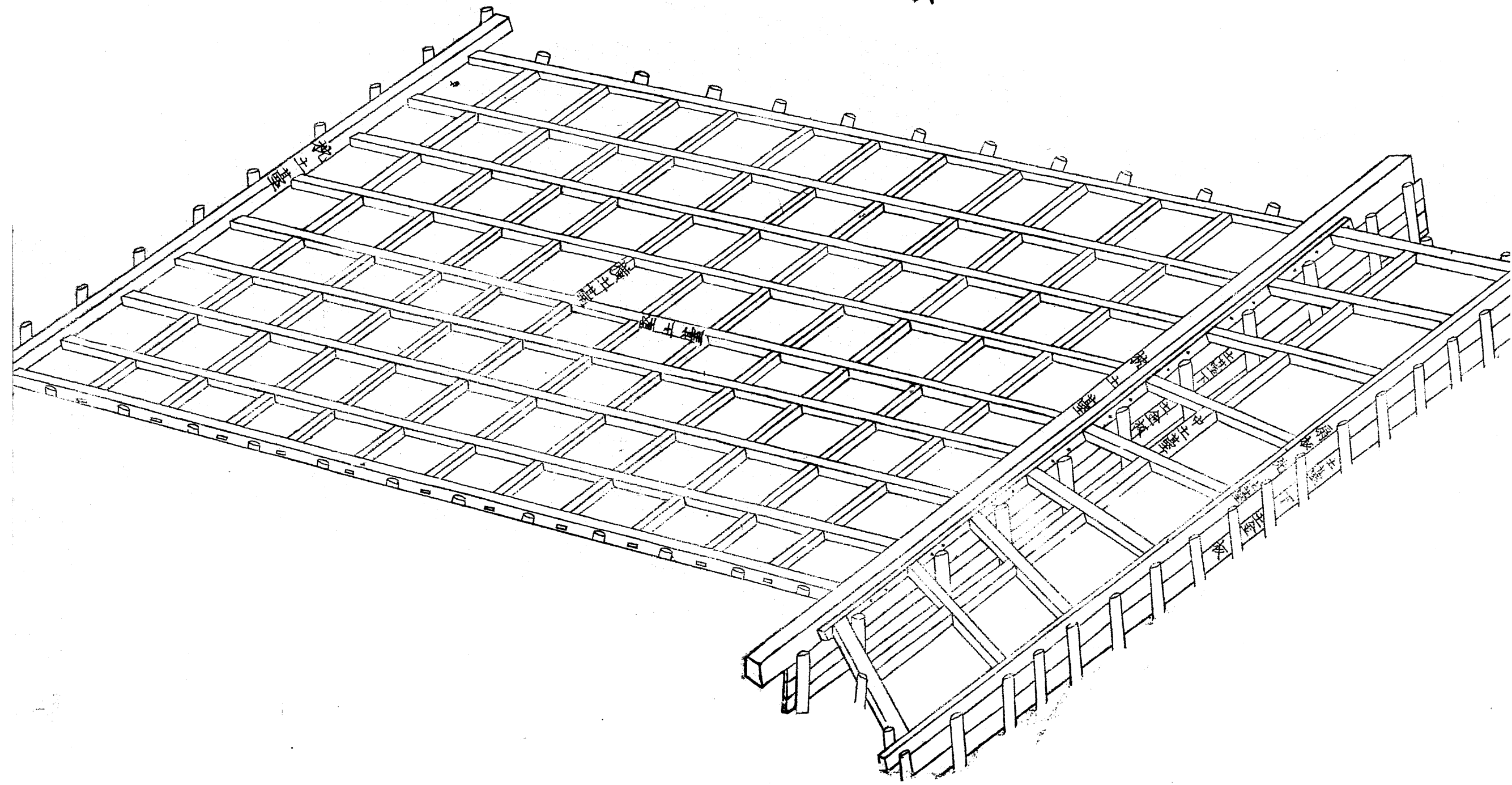

土臺切組之圖

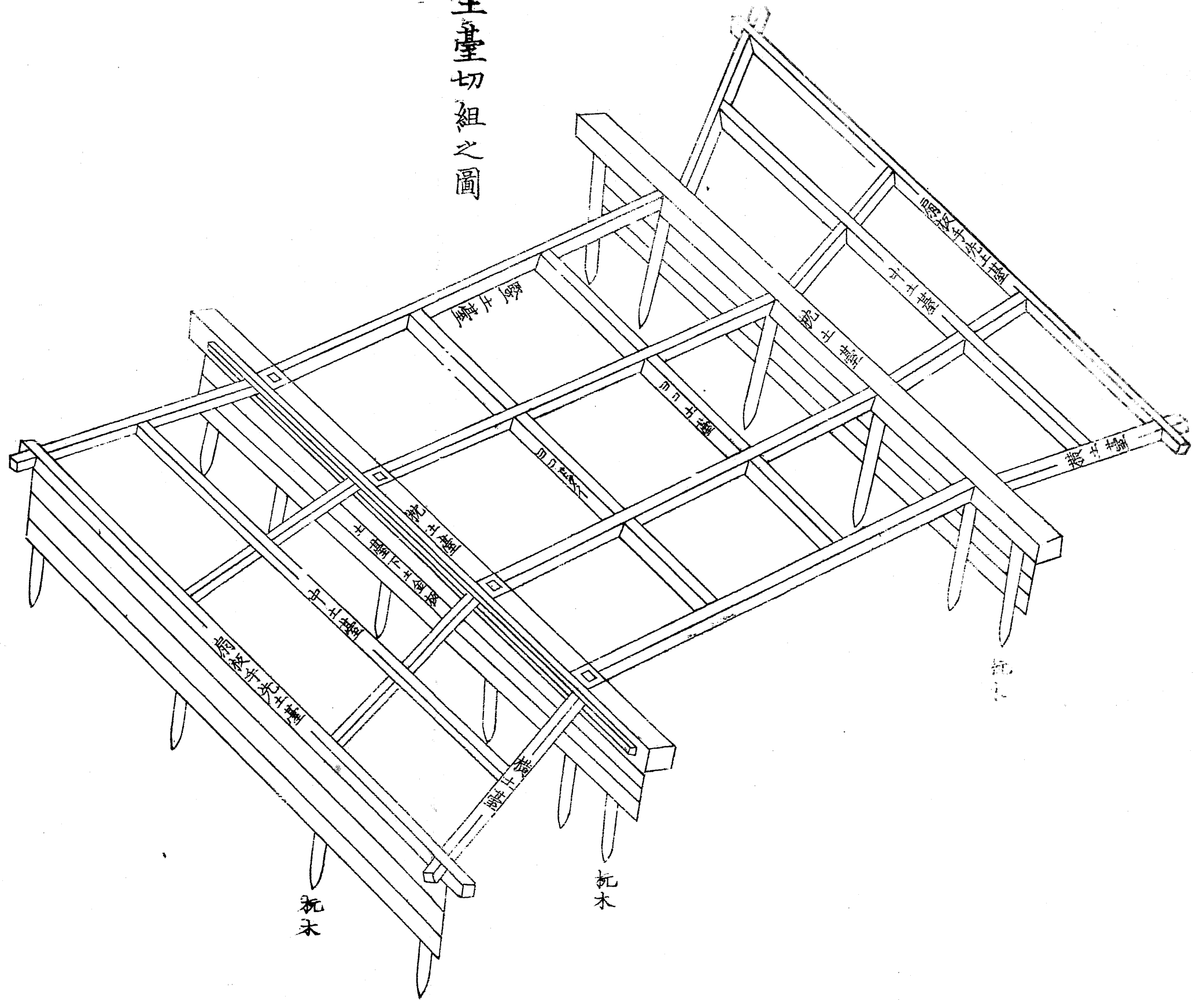

関
桝
之
圖

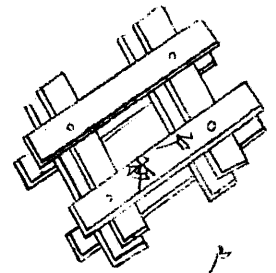
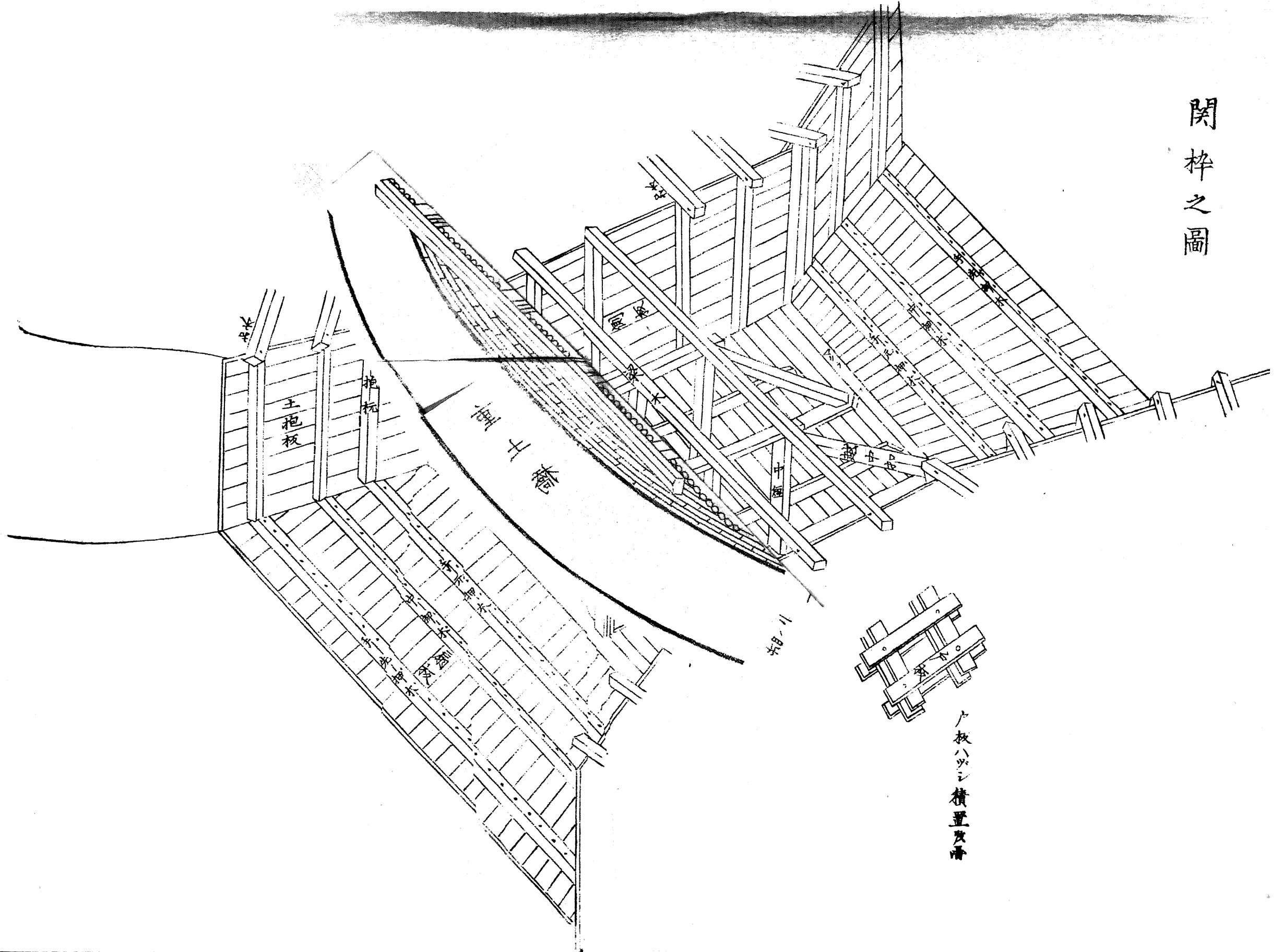

大
板
ハ
ツ
ノ
積
置
度
番

閑枅之圖

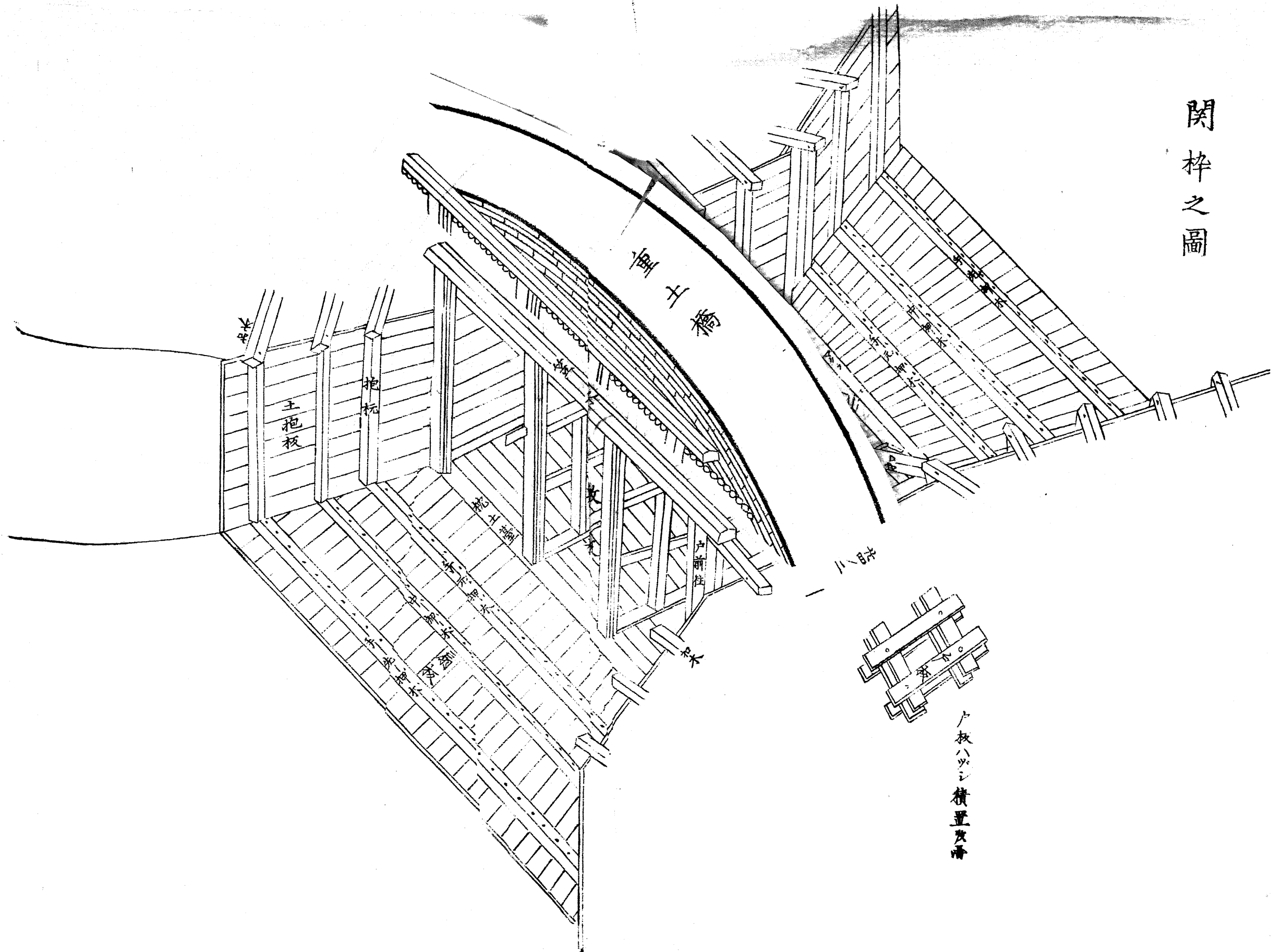

主抱板

抱板

閑枅

飛下木

下前柱

木

八ッ目

八板ハッ目積置度

内法之圖

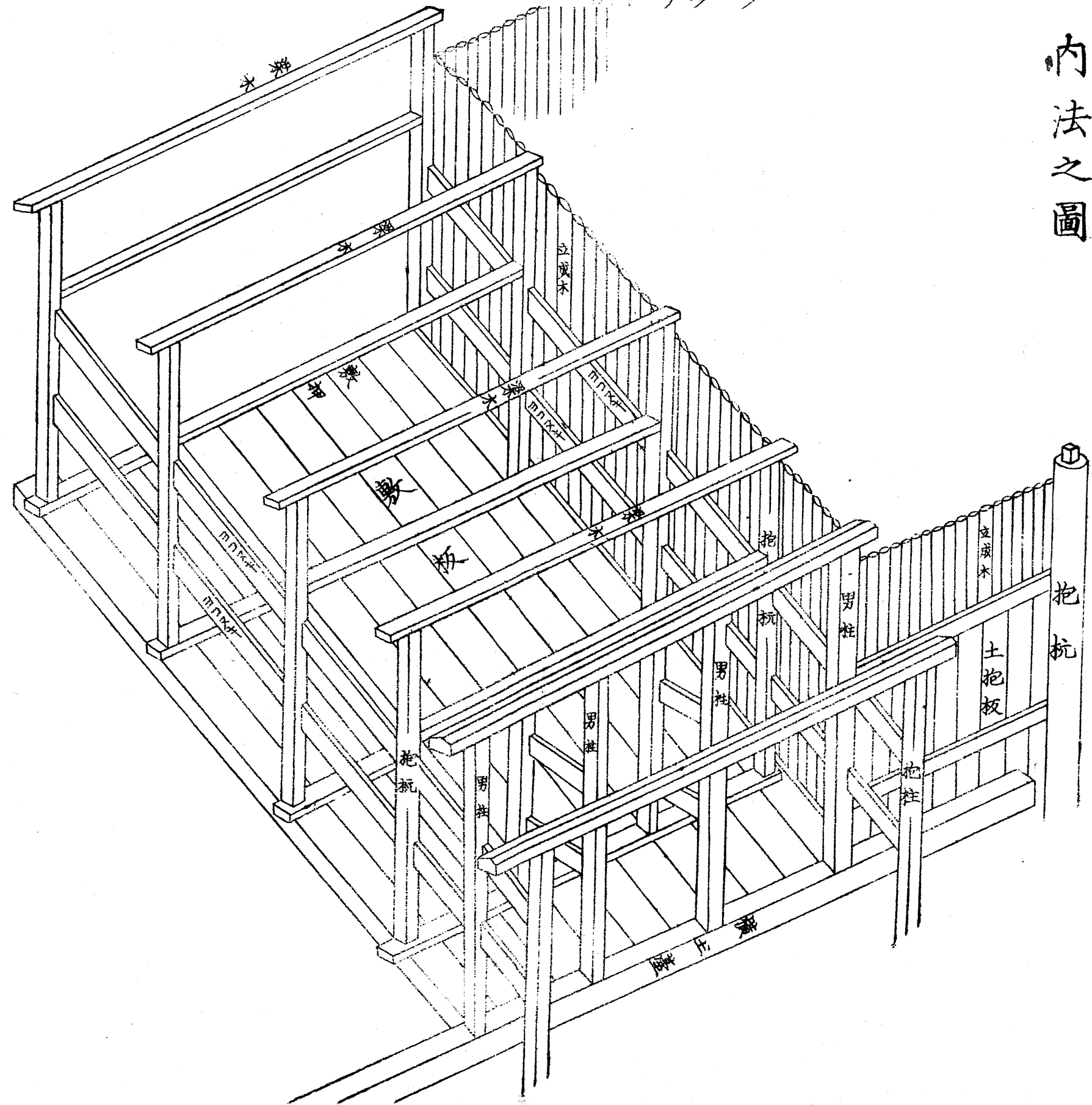

水門之圖

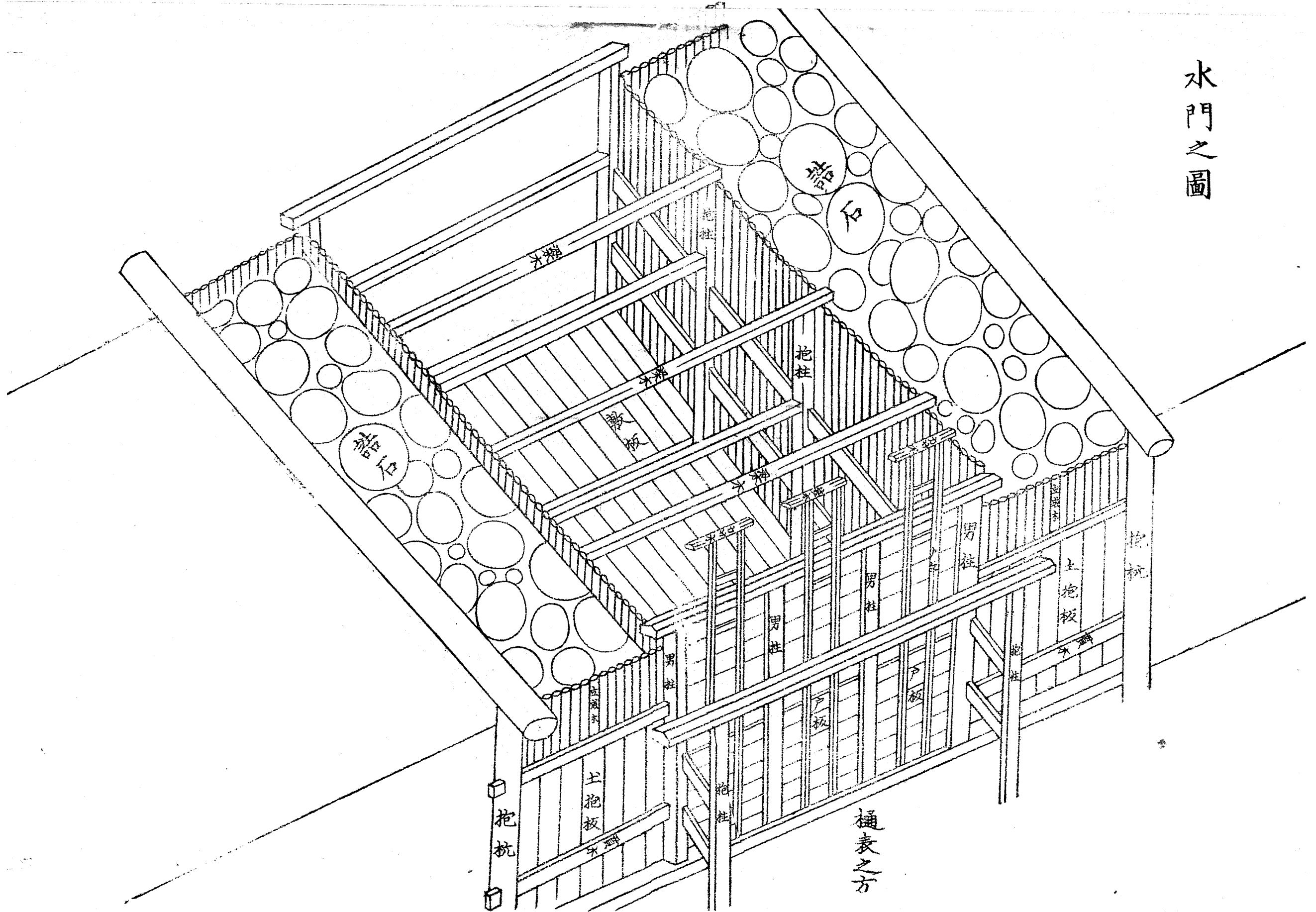

土臺組立之圖

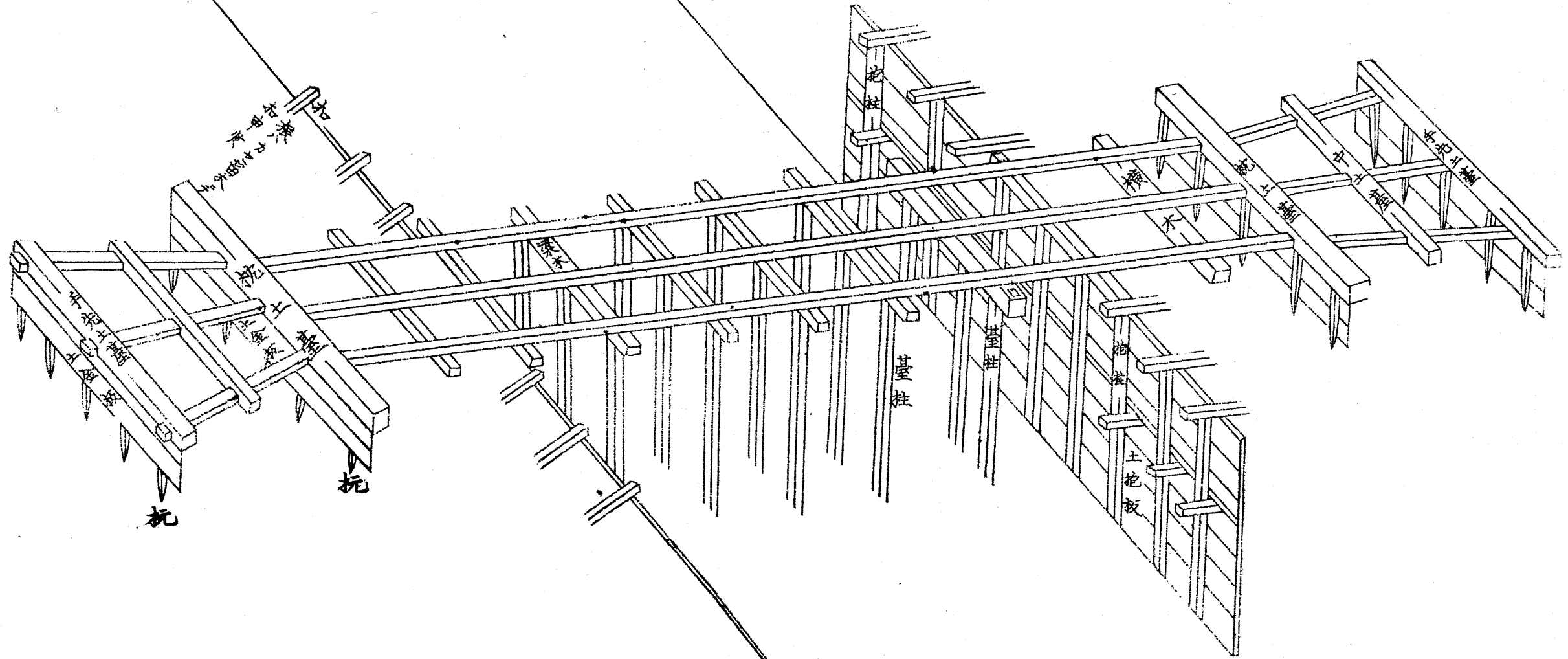

掛渡井之圖

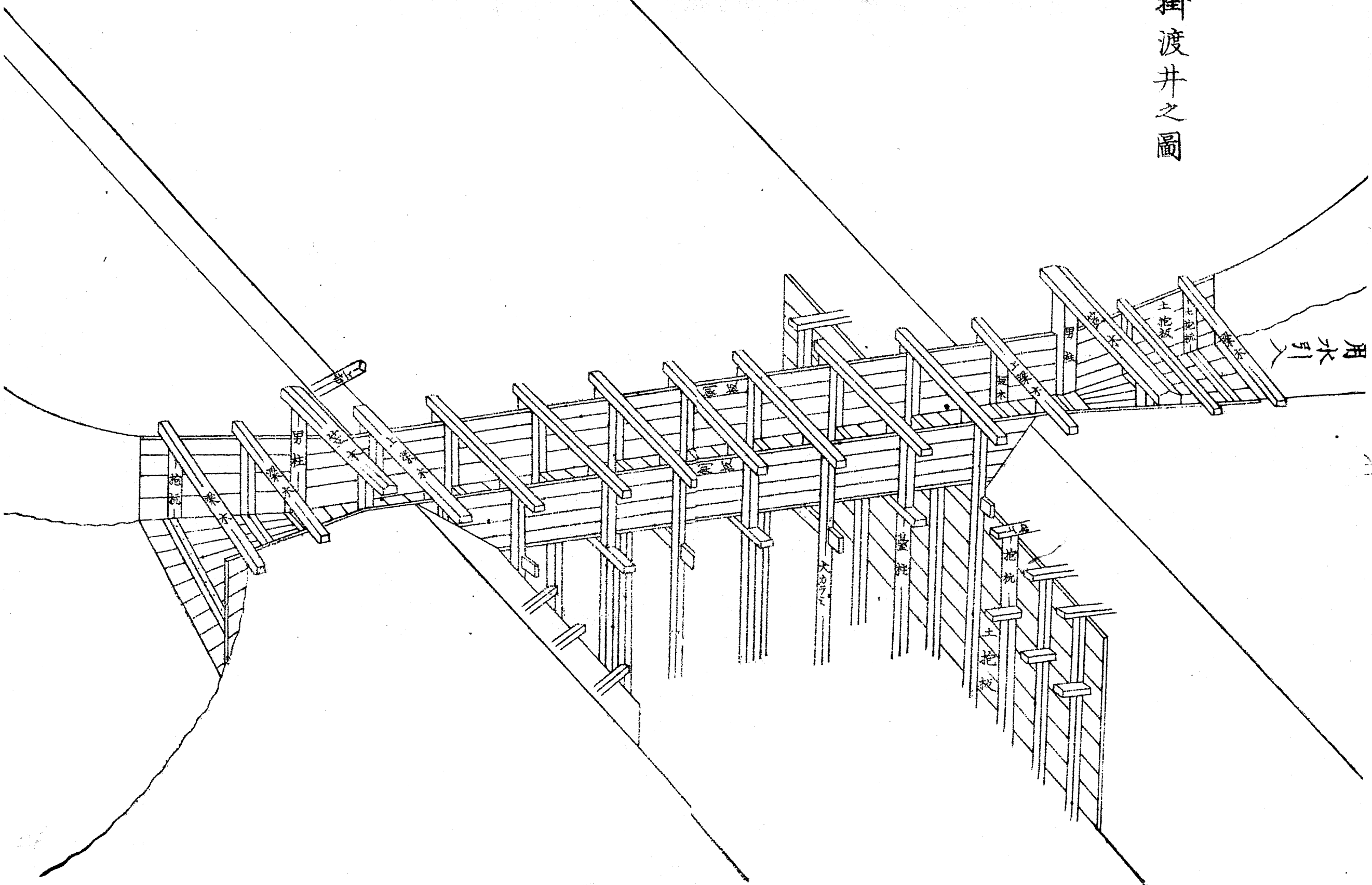

用水引

土抱板

掛渡木

大抱杭

土抱杭

土抱板

掛渡木

土抱板

土抱板

掛渡木

掛渡木

土抱板

掛渡木

土抱板

掛渡木

土抱板

掛渡木

土抱板

掛渡木

土抱板

掛渡木

土抱板

用水引

掛樋之圖

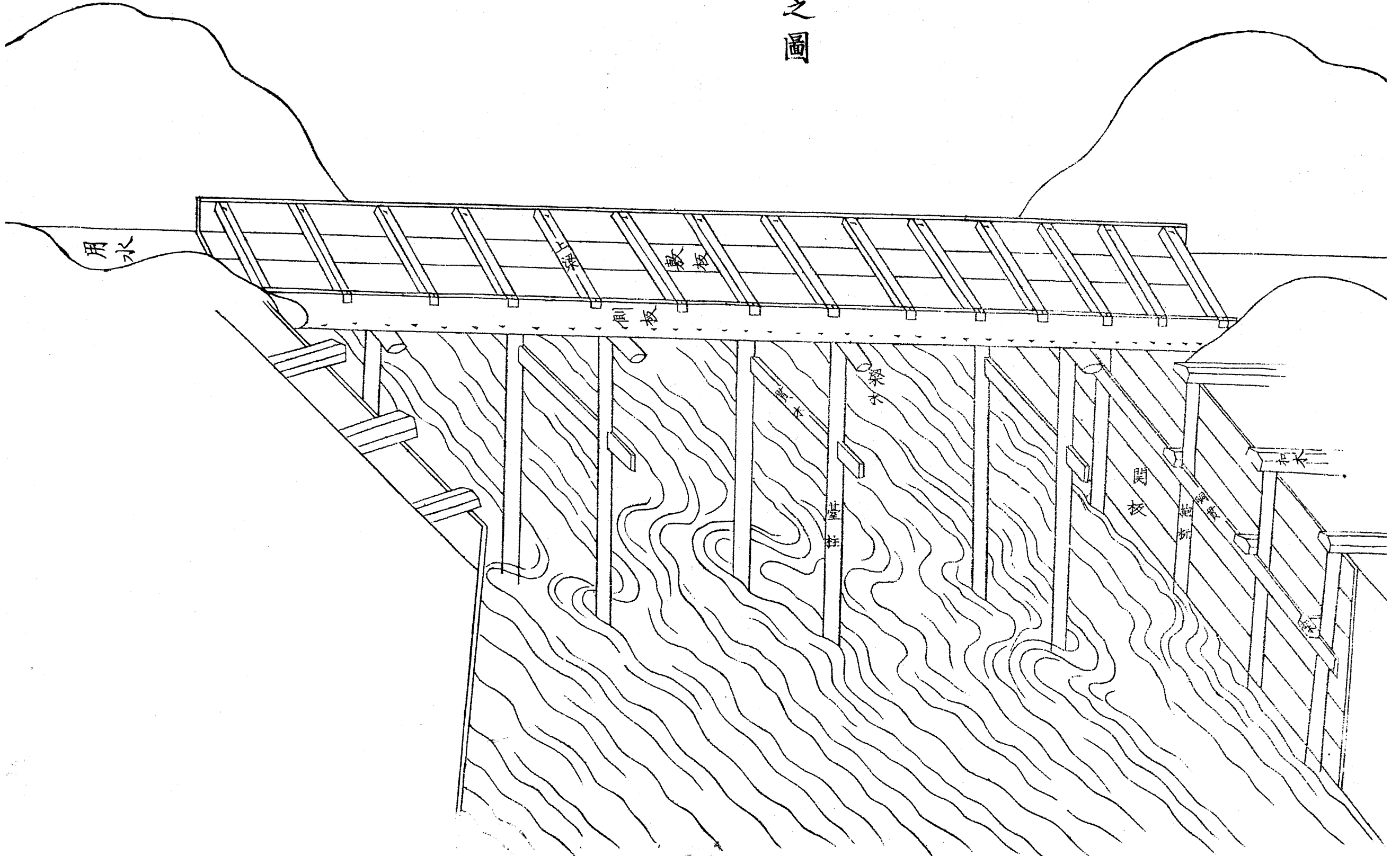

土臺居方之圖

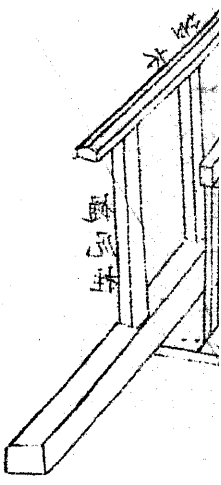
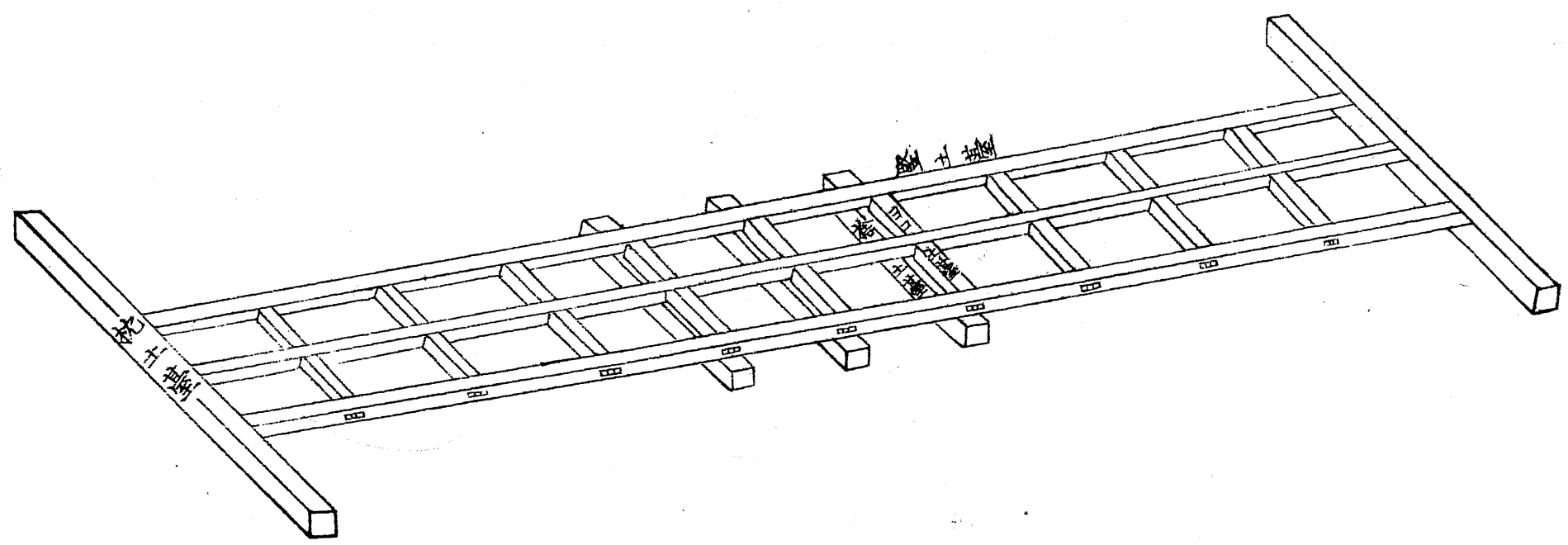

土臺居方之圖

内法組方之圖

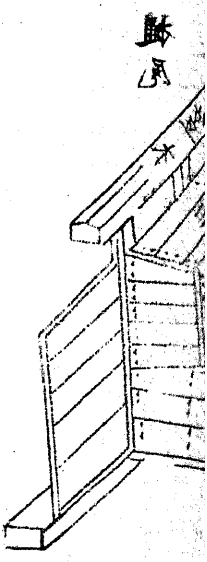
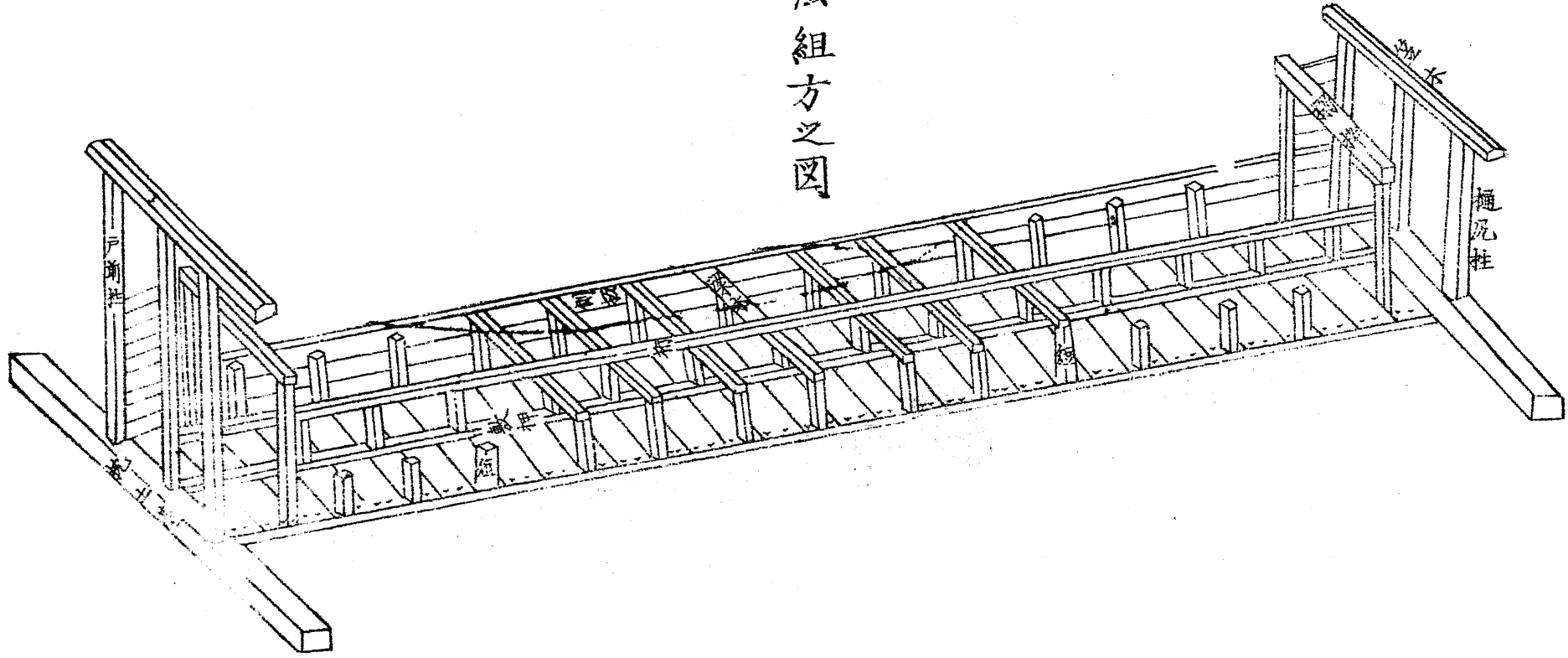

土臺居方之圖

組立之圖

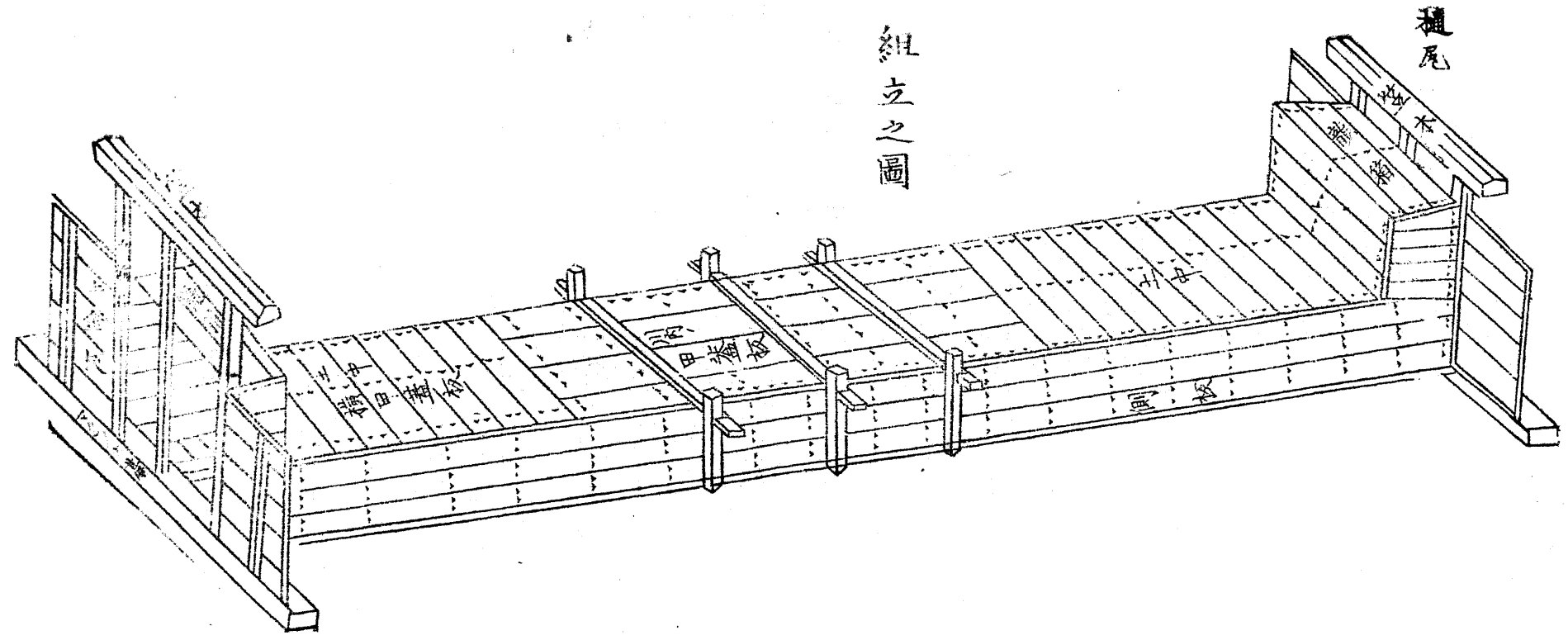

伏越龍坎之圖

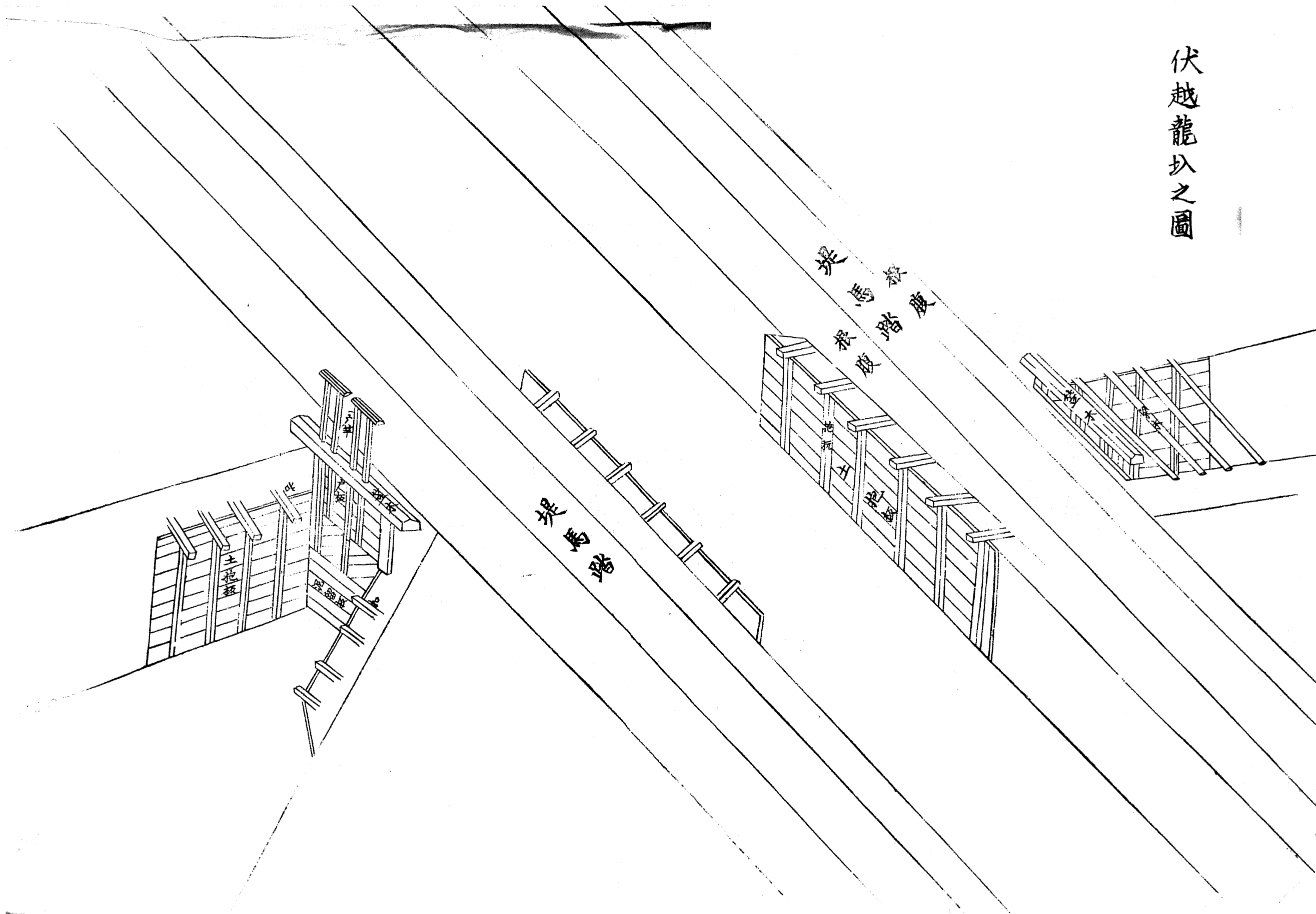

組立之圖

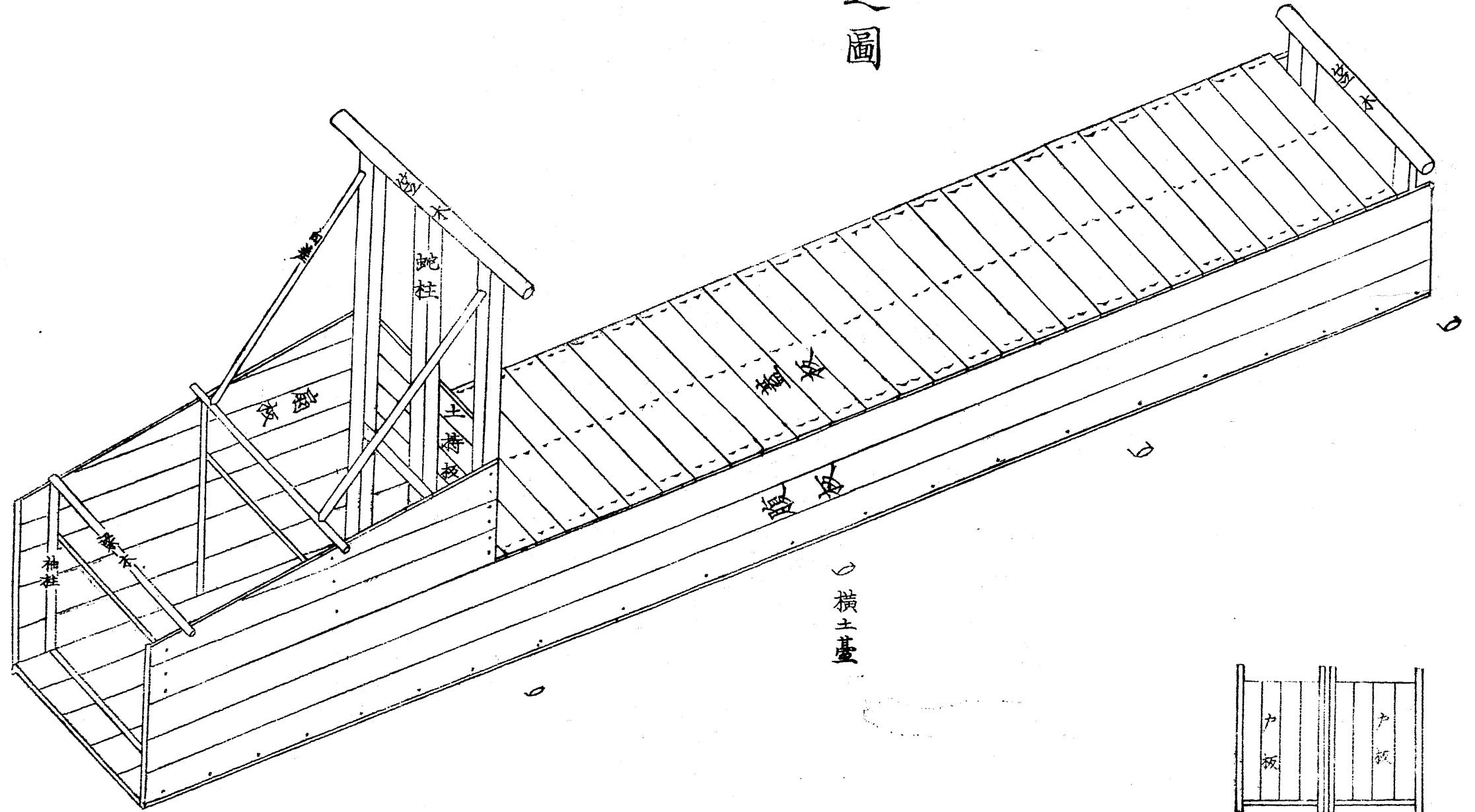

横土臺

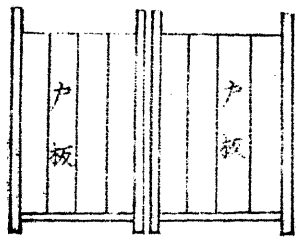

濃州流坑樋之圖

小樋

架馬踏

法

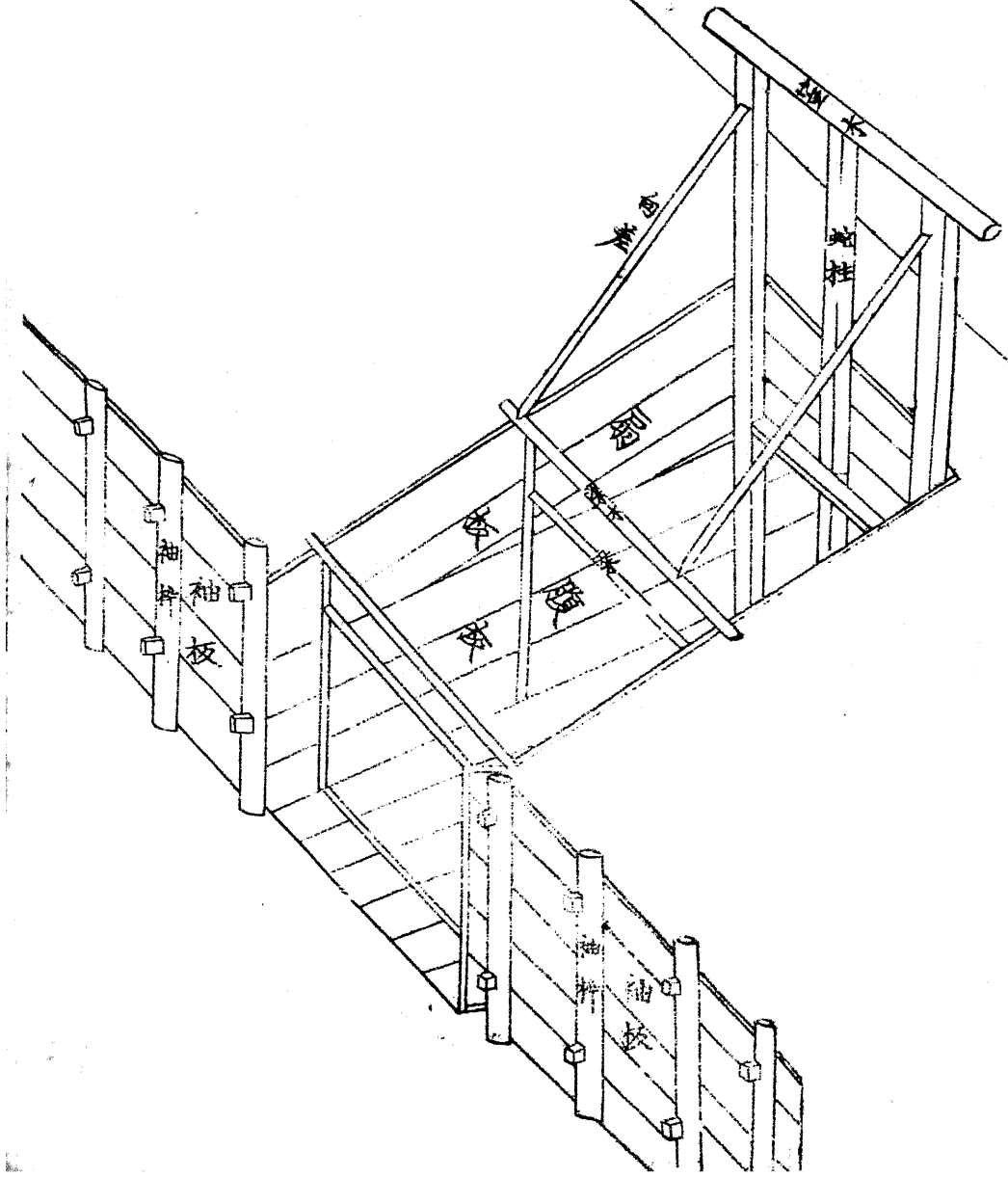

上方流
四柱立以樋之圖

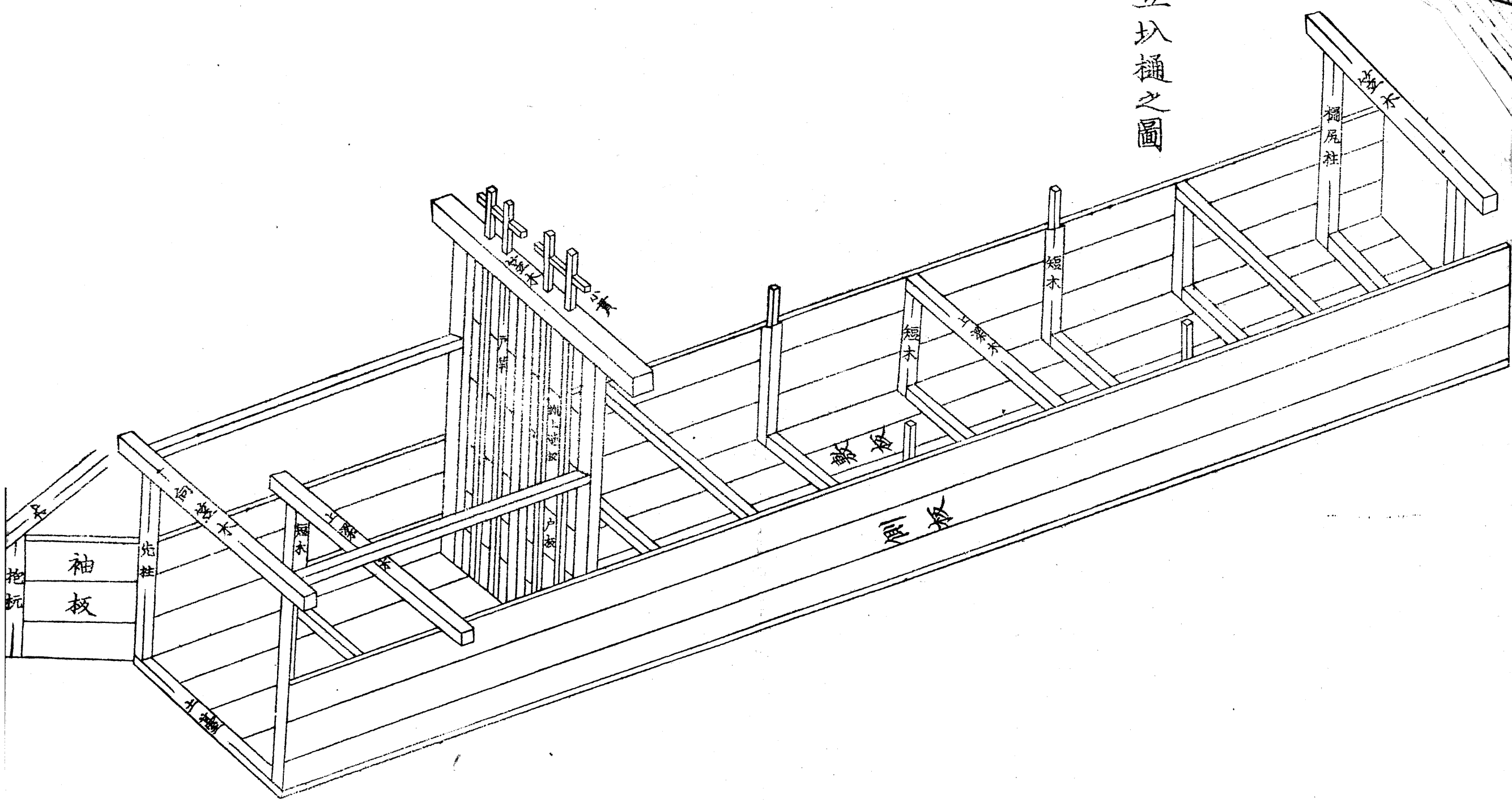

袖板

先柱

短木

短木

短木

短木

短木

短木

短木

短木

短木

短木

短木

短木

短木

短木

短木

短木

短木

短木

短木

短木

短木

短木

短木

短木

短木

短木

短木

短木

短木

短木

短木

短木

短木

短木

短木

短木

短木

短木

短木

短木

短木

短木

短木

短木

短木

短木

短木

短木

短木

短木

短木

短木

短木

短木

短木

短木

短木

短木

短木

短木

短木

短木

短木

短木

短木

短木

短木

短木

短木

上方流
四ツ柱立
八

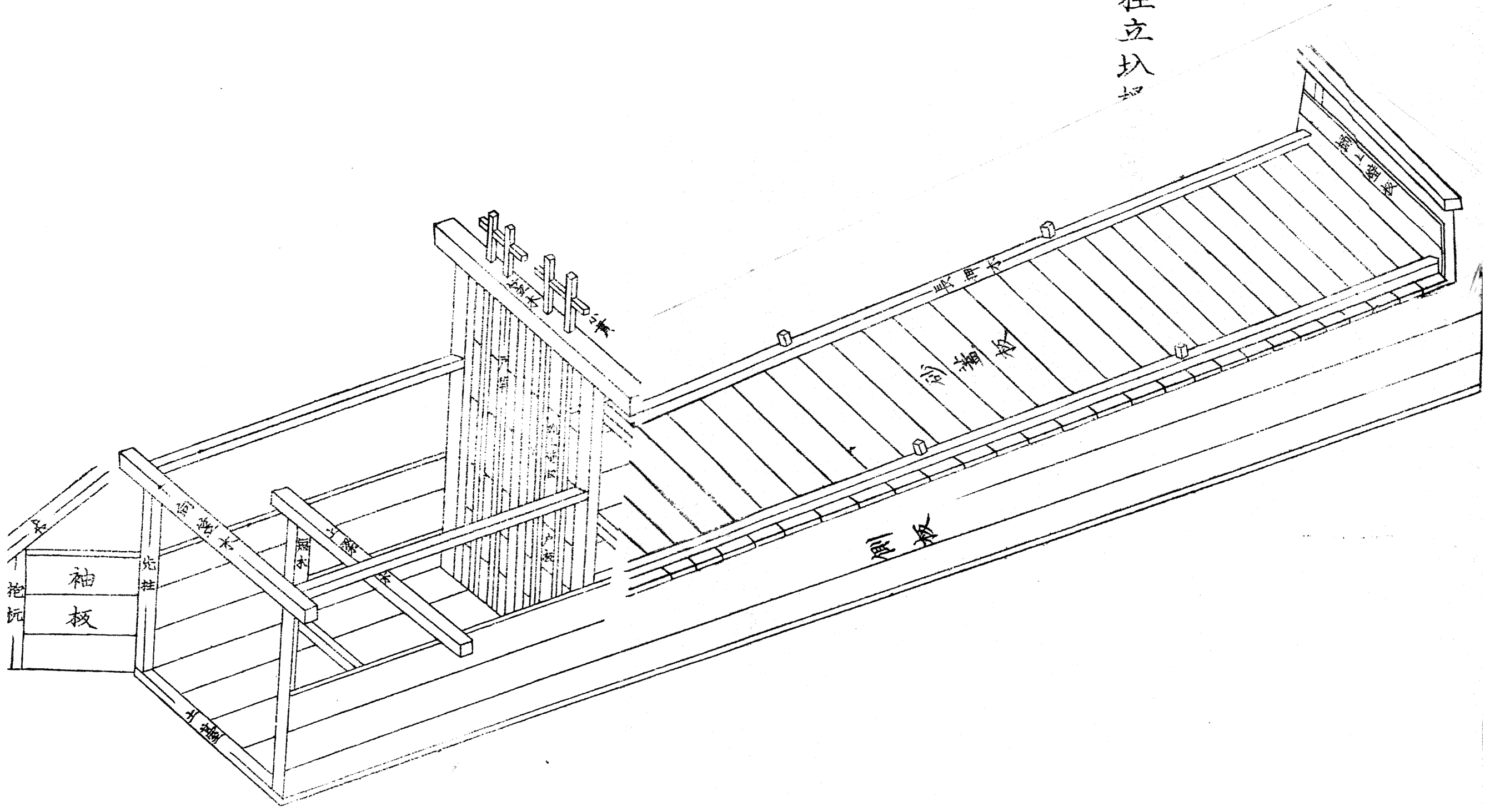

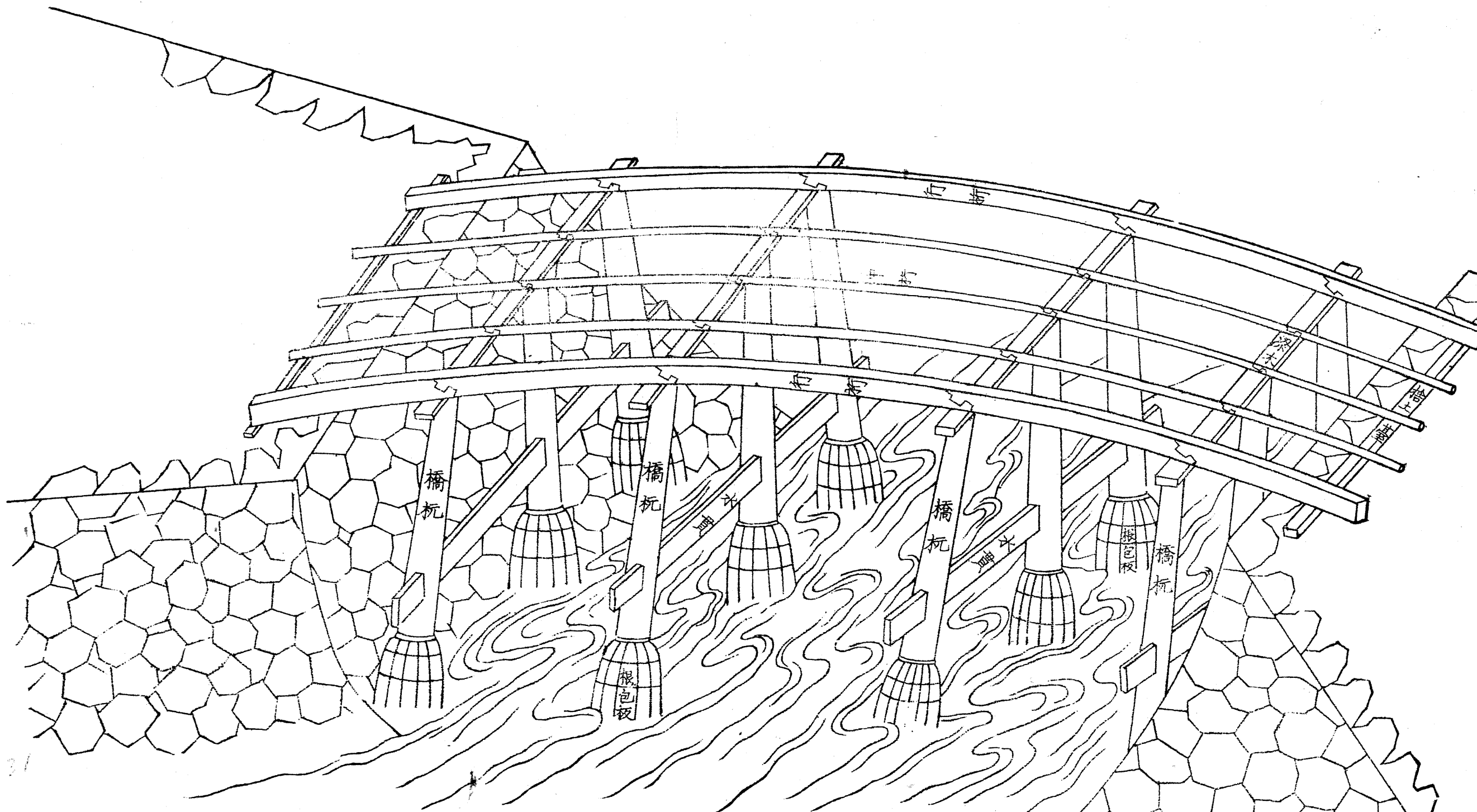

高欄附板橋之圖

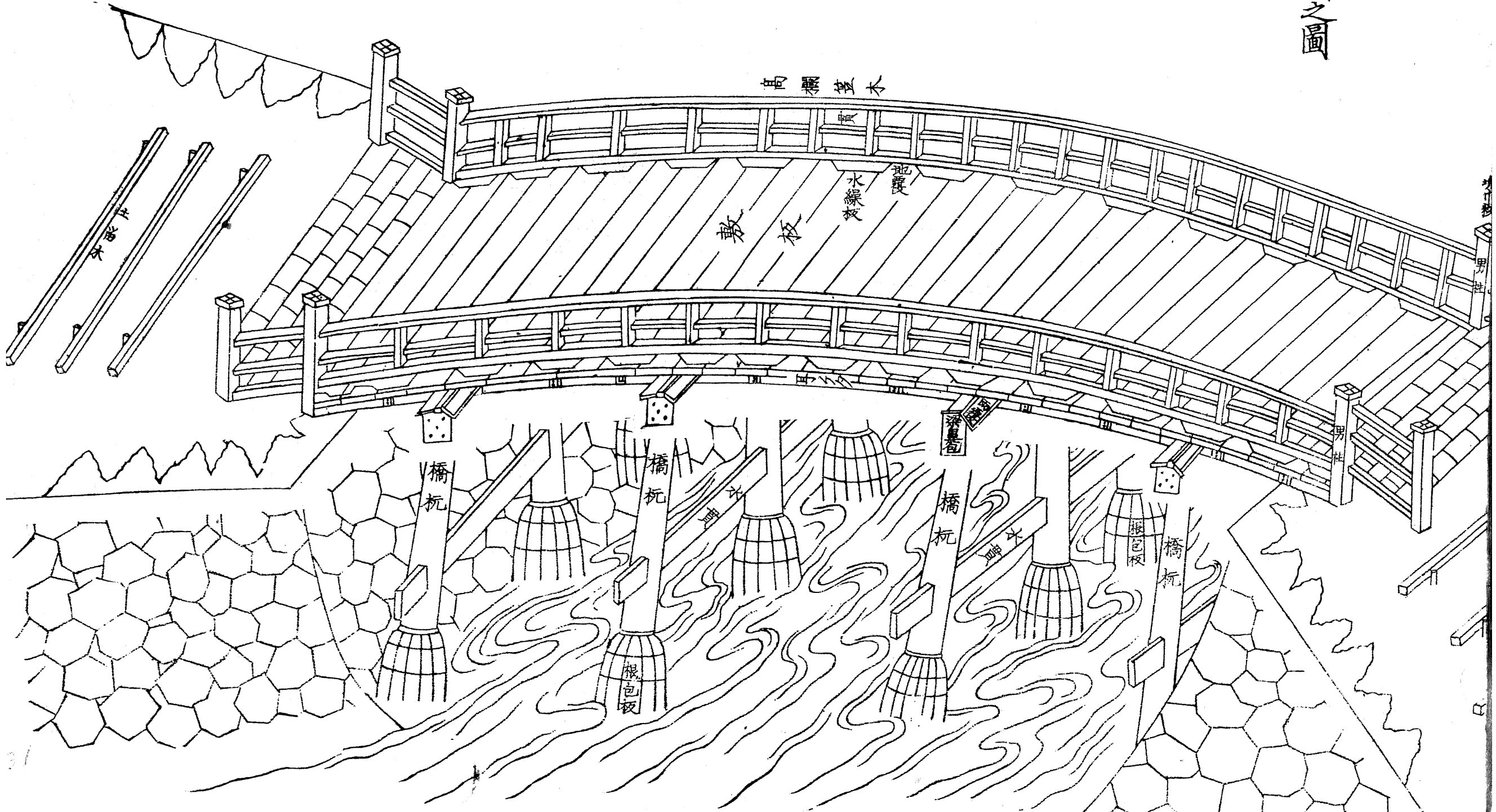

木
河

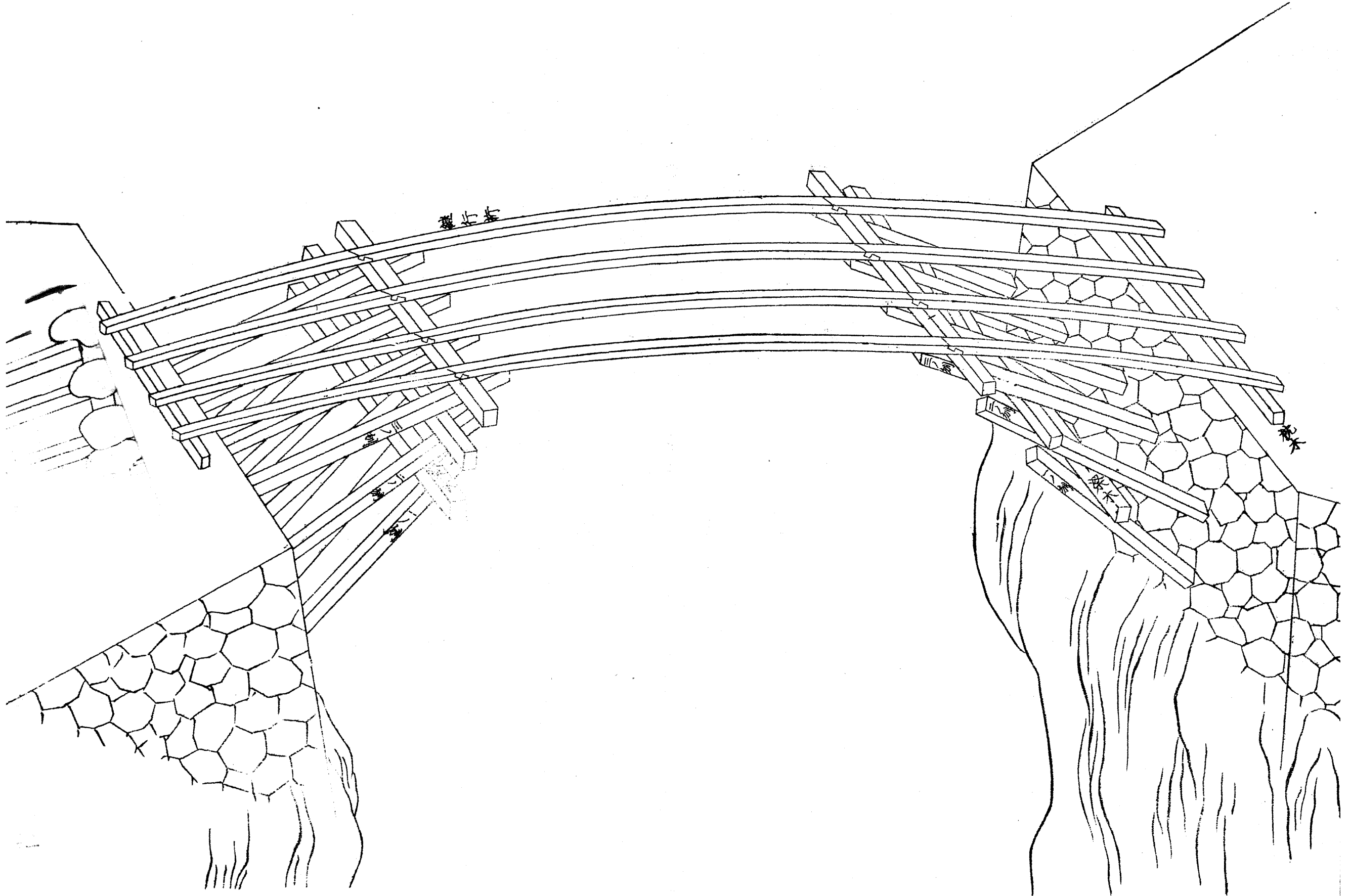

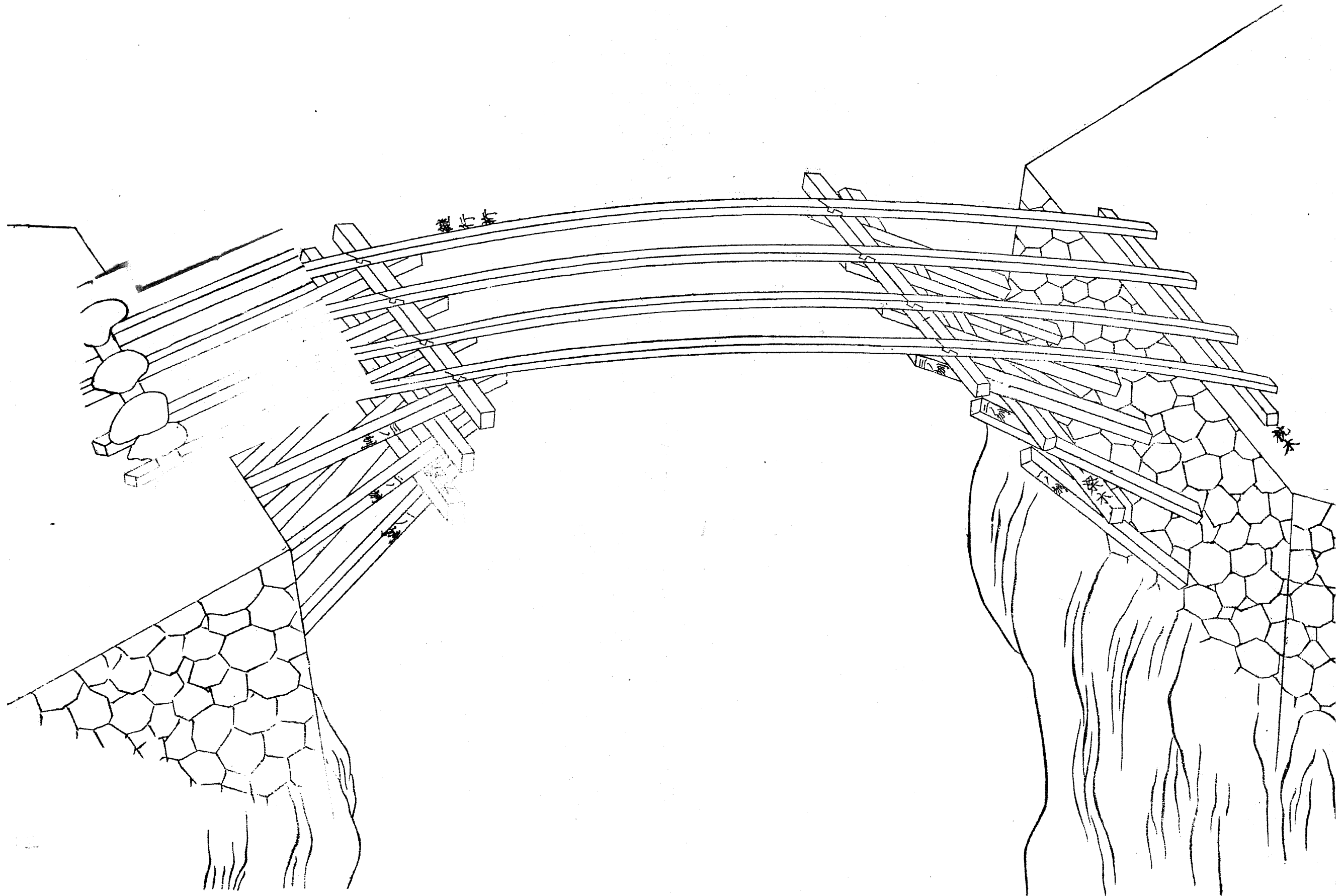

刳橋之圖

光中板

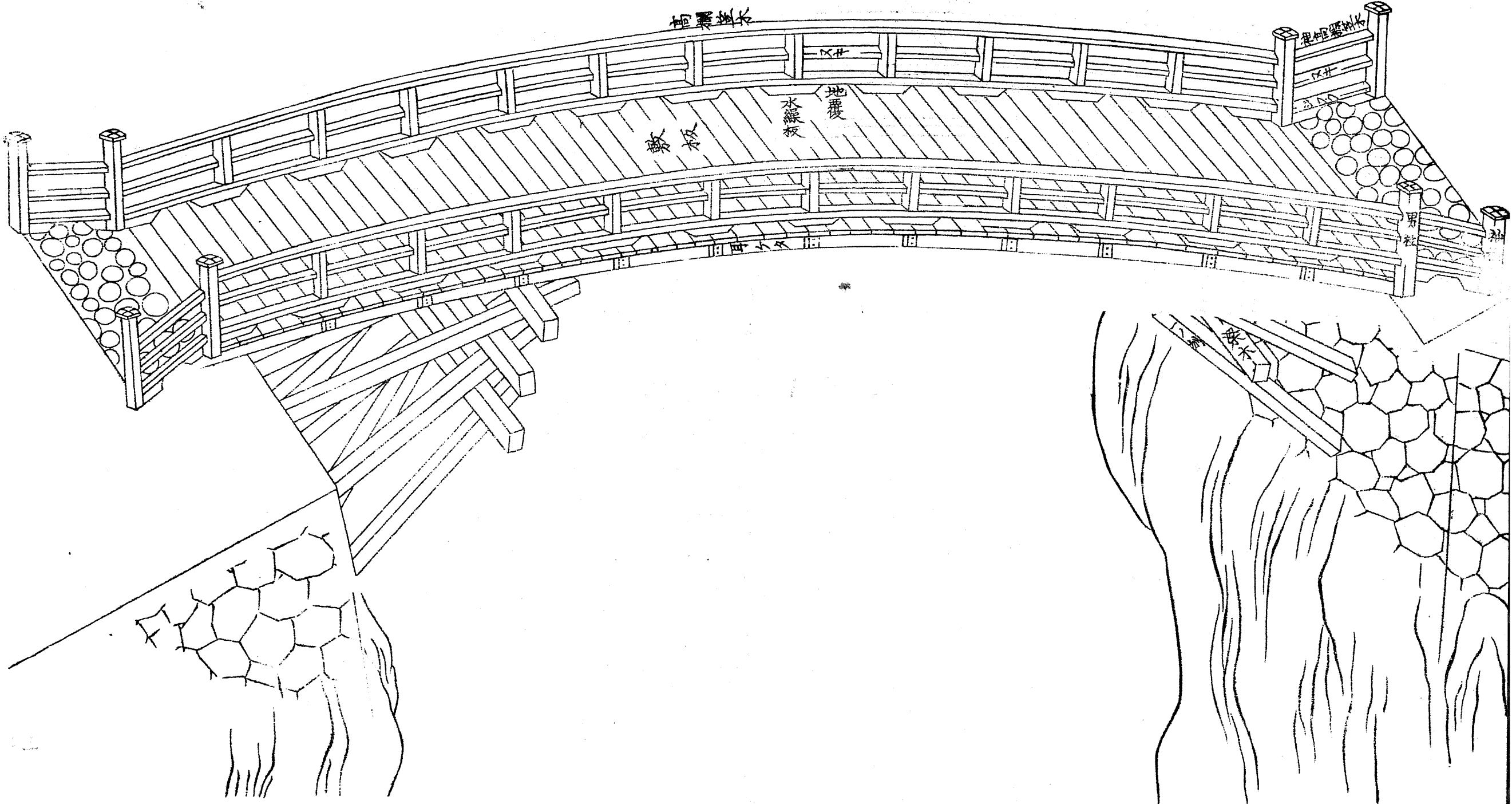

土橋之圖

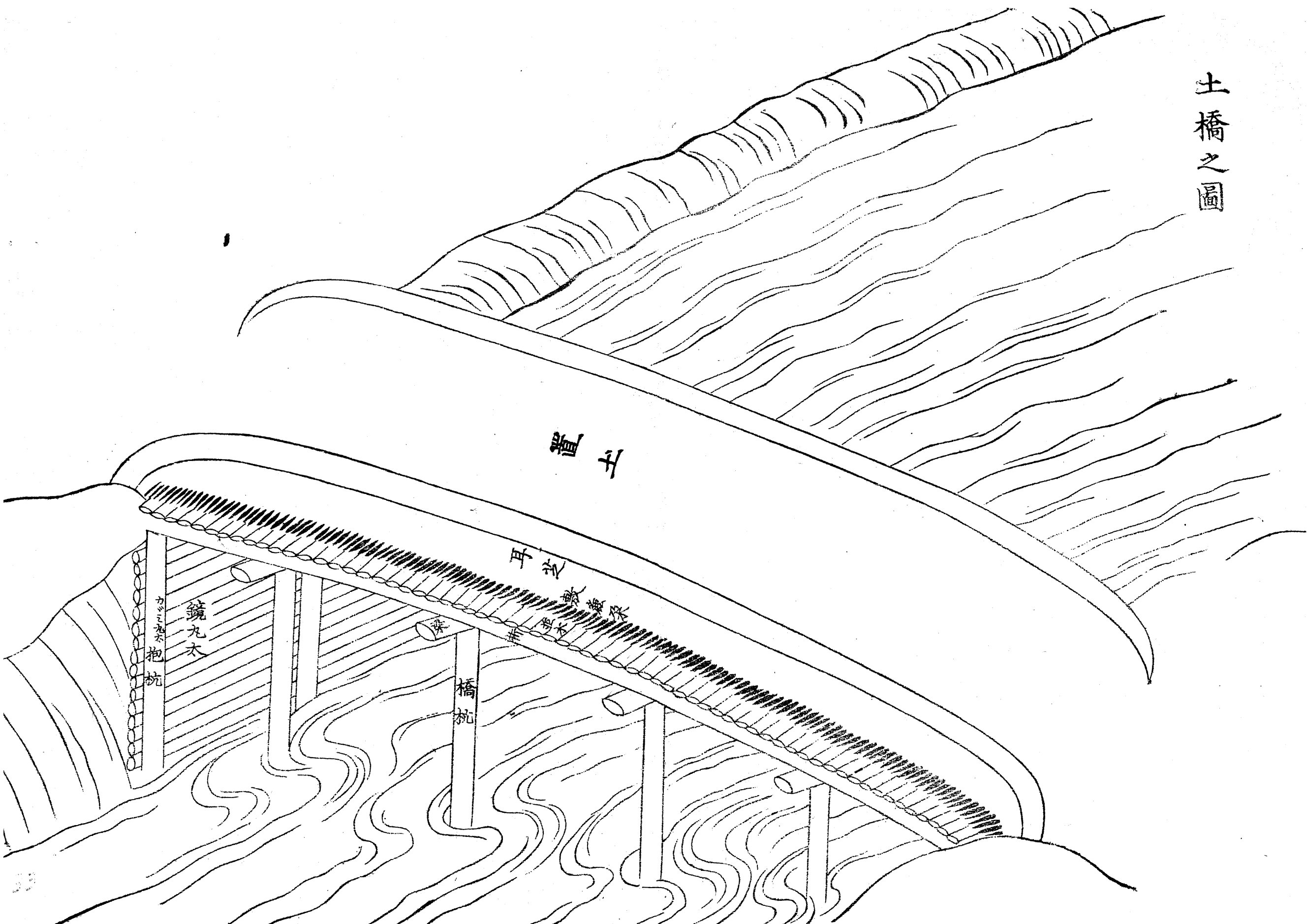

土置

耳之

鏡丸木

方之木

橋枕

棚道之圖

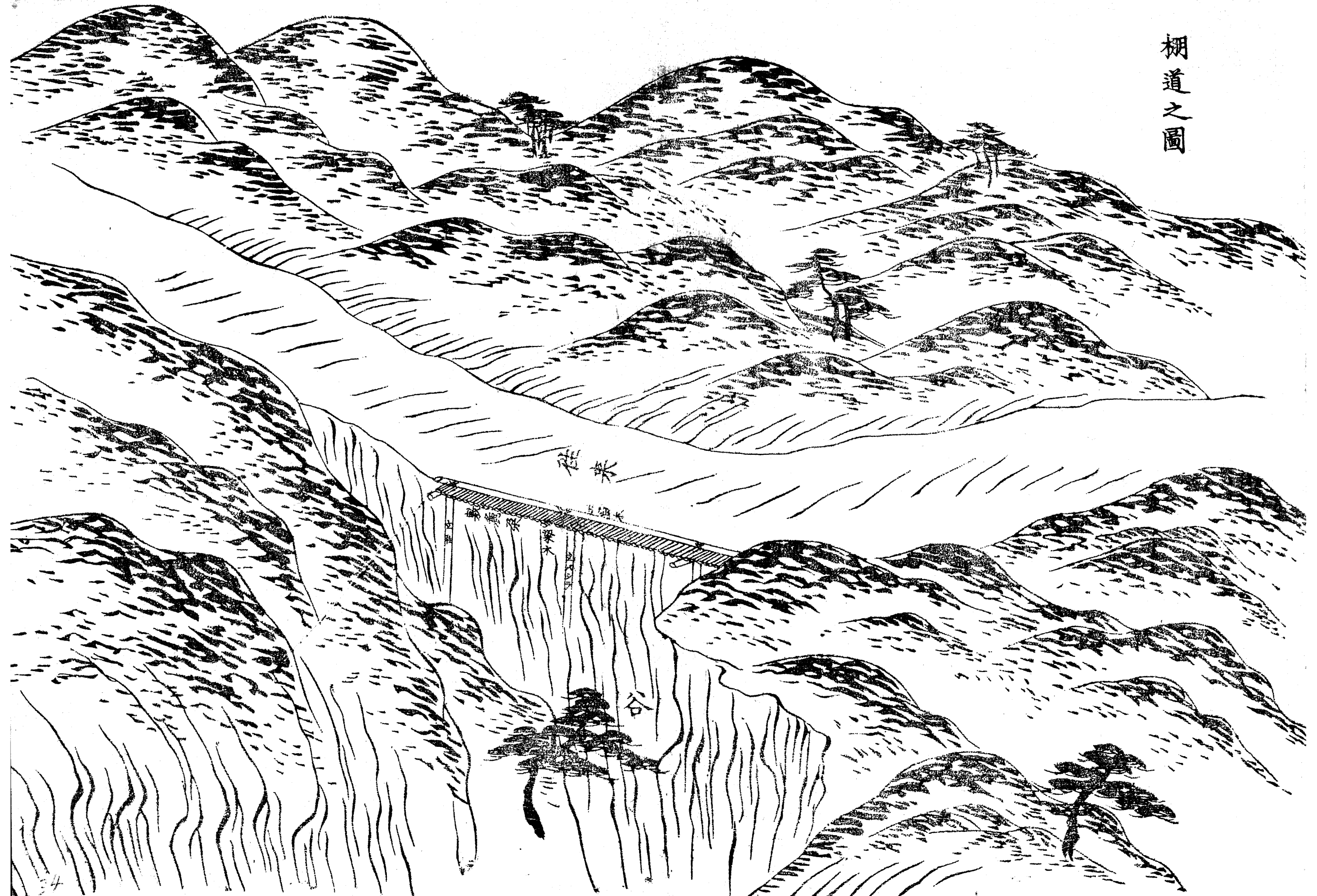

往來

谷

竹洗之圖

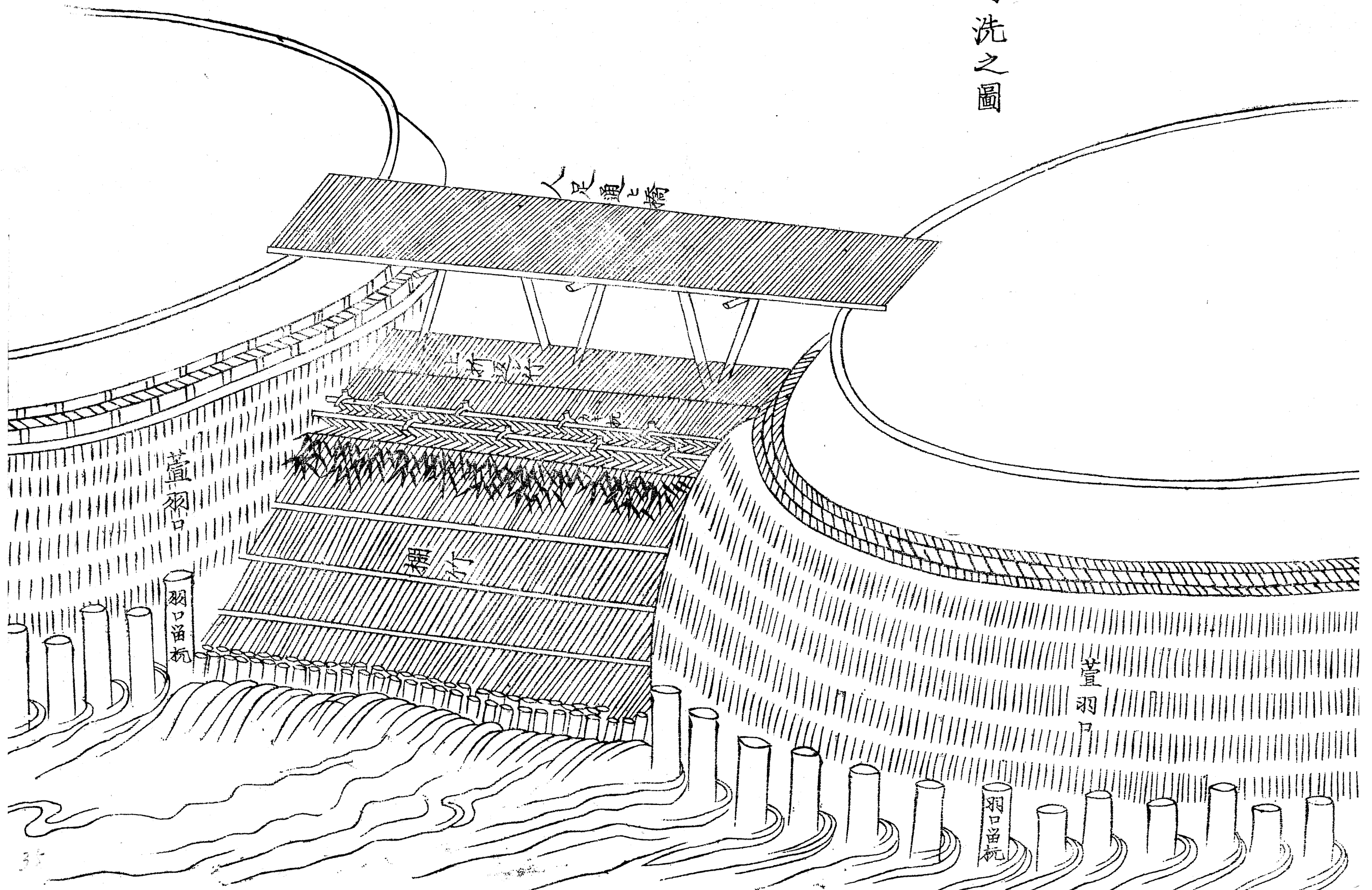

人足通之橋

萱羽口

羽口留杭

竹洗

萱羽口

羽口留杭

丸太洗之圖

溜井内

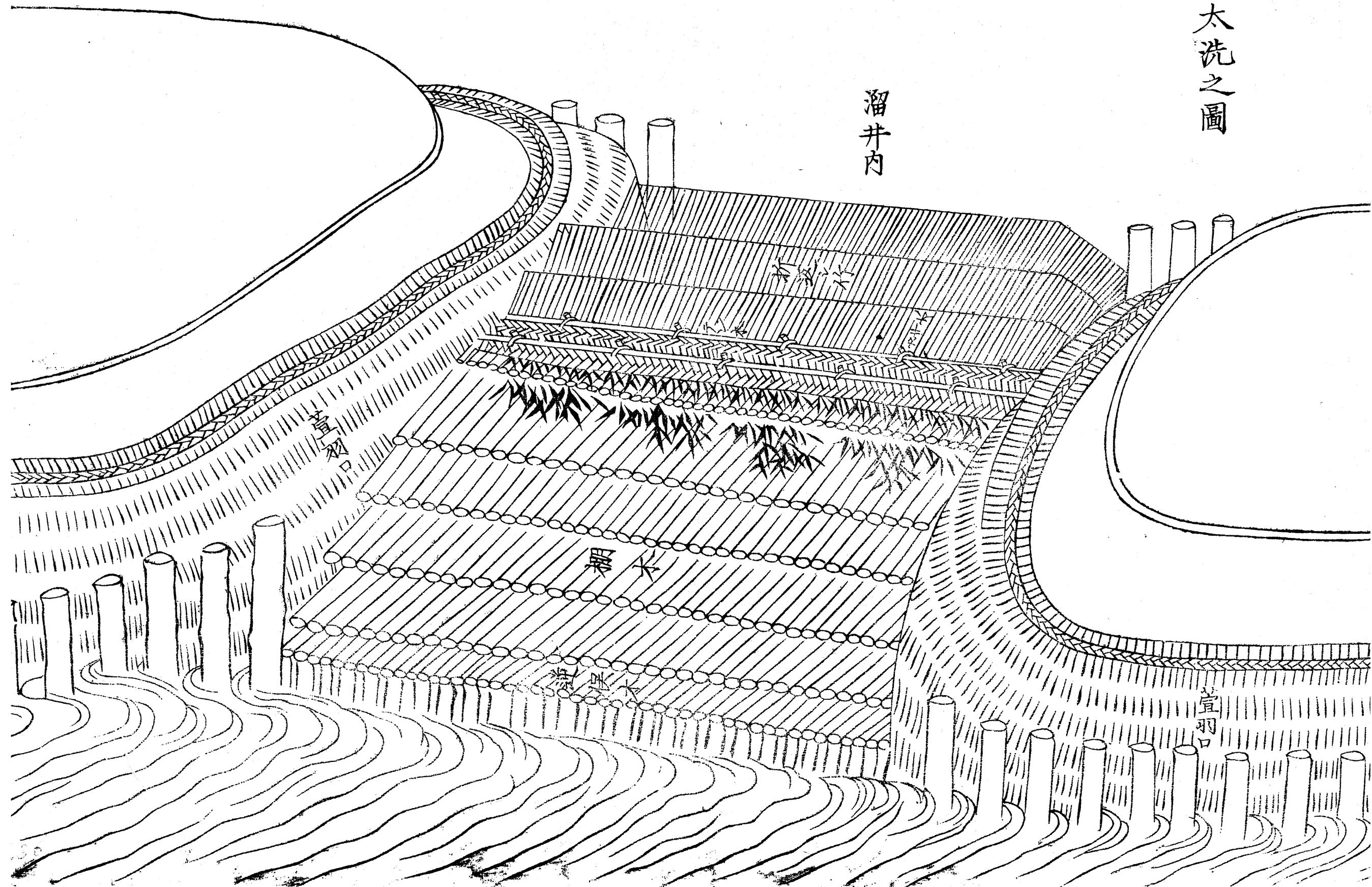

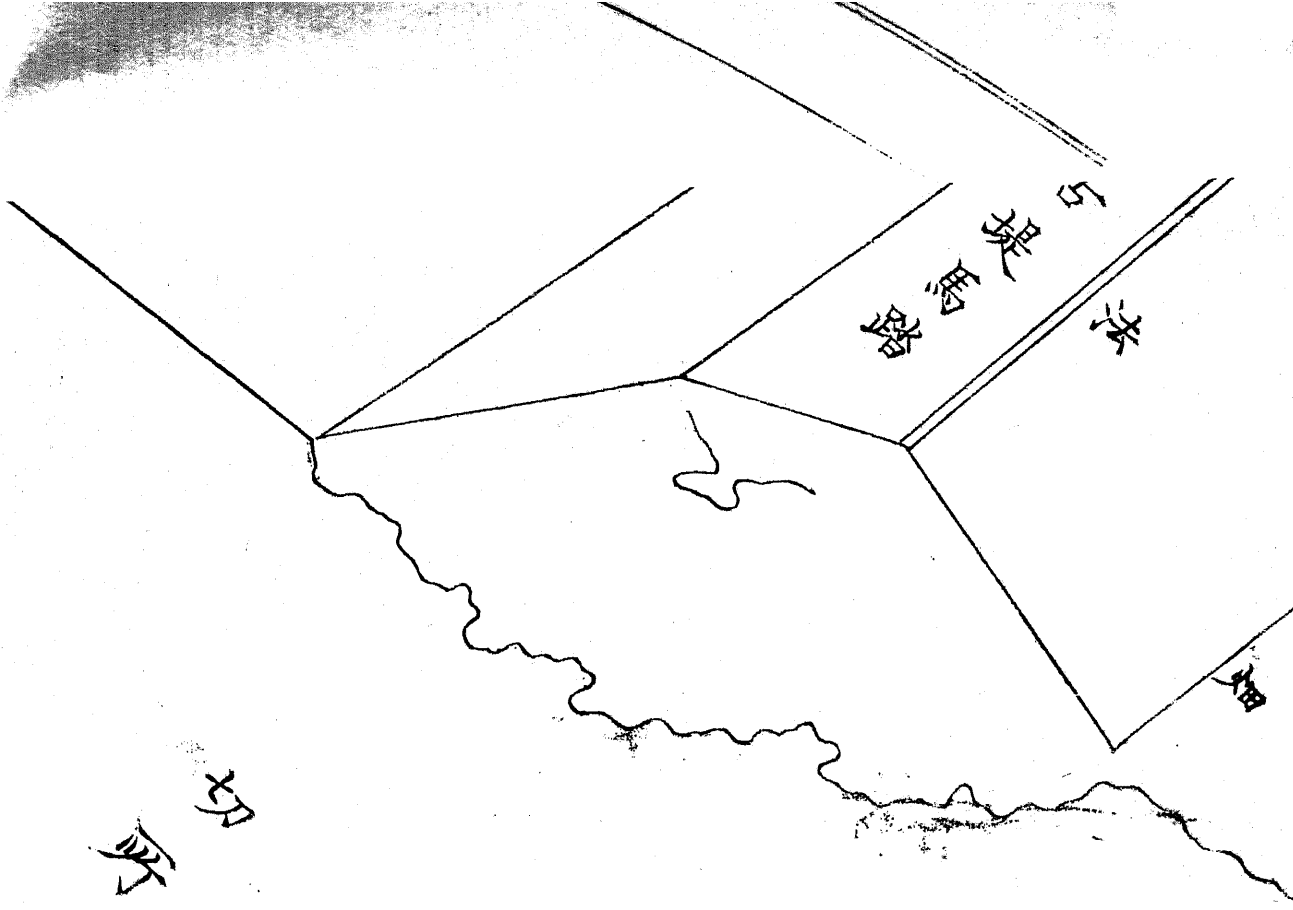
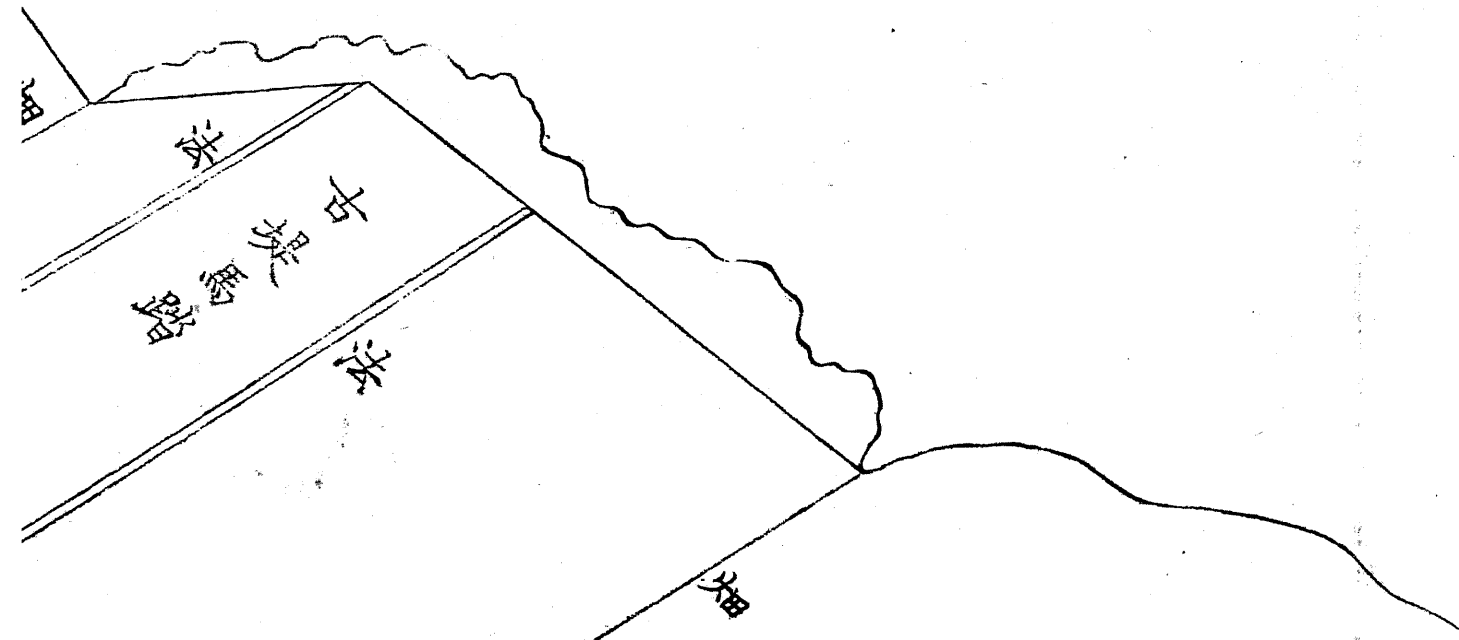

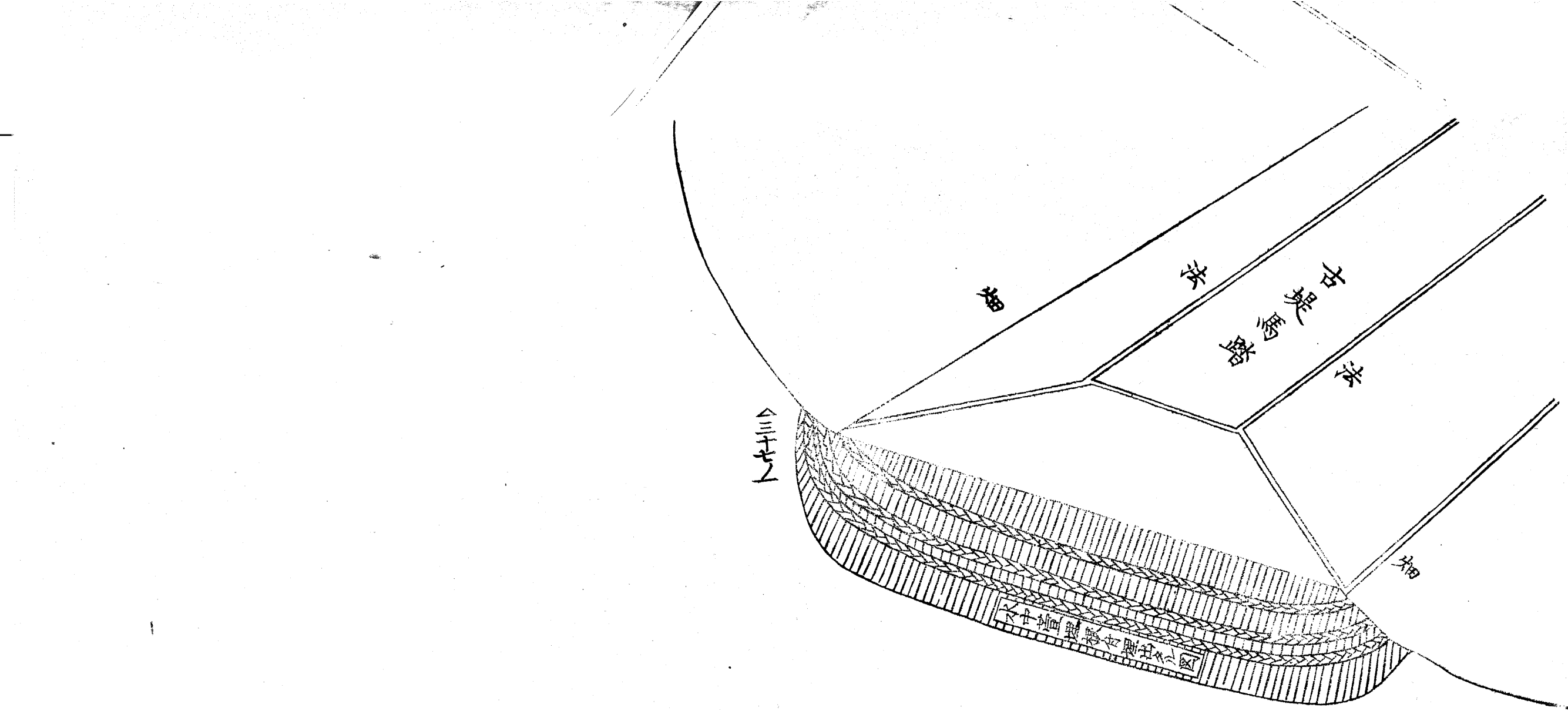

下
川

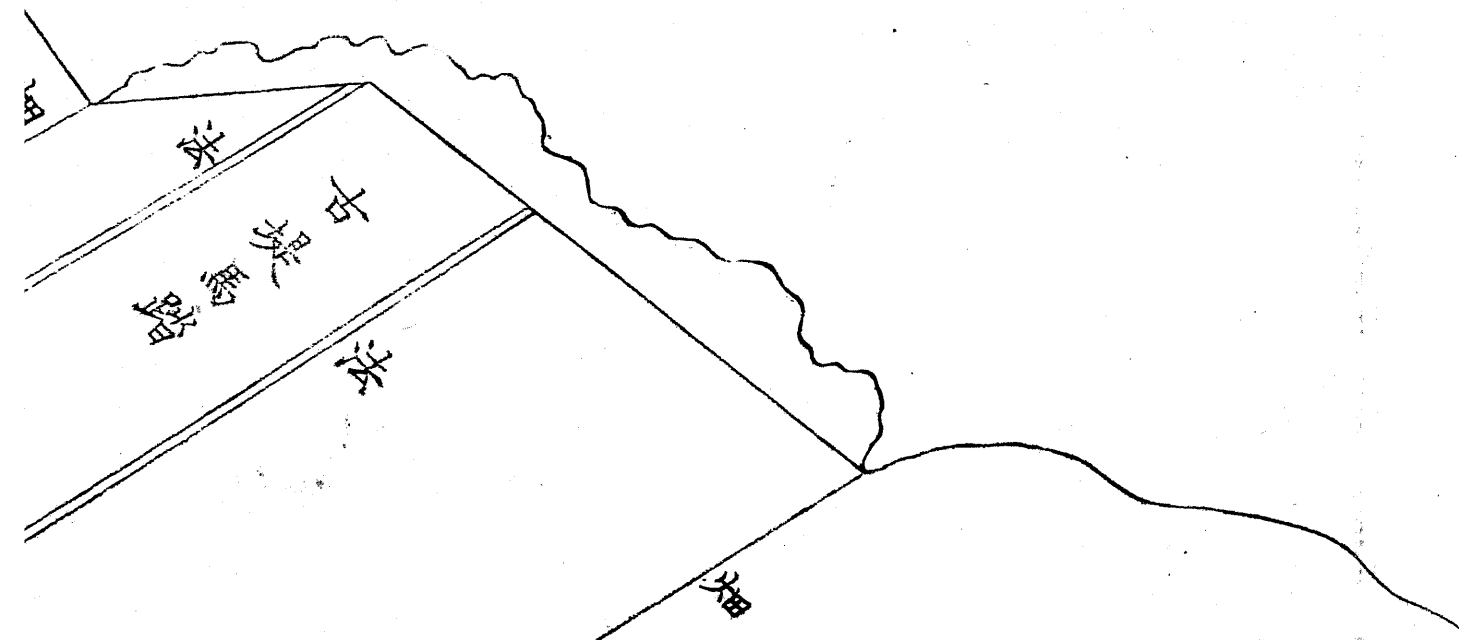

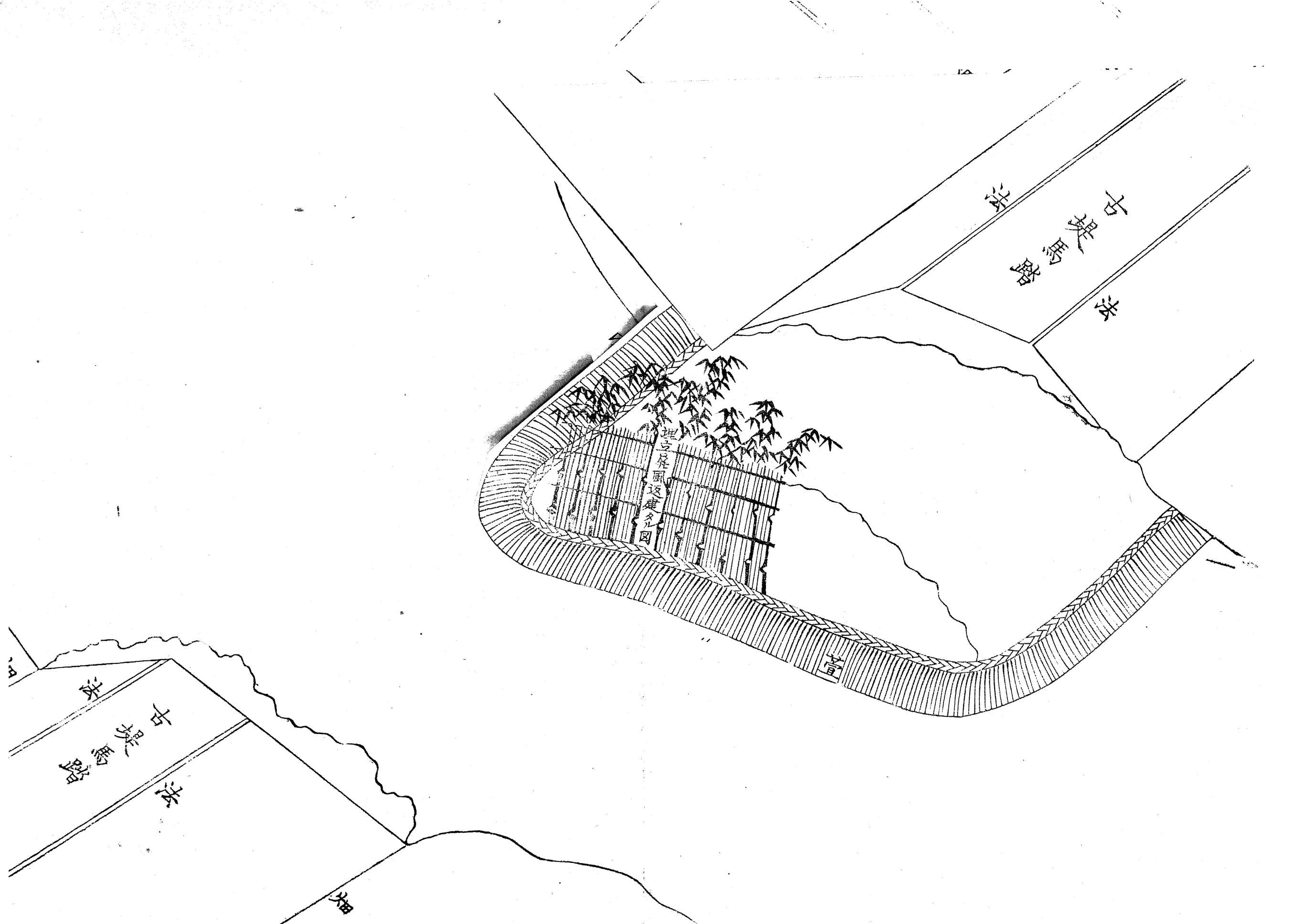

水

水
築
園
返

水

理之居
返建之園

水

水

水
築
園
古

水

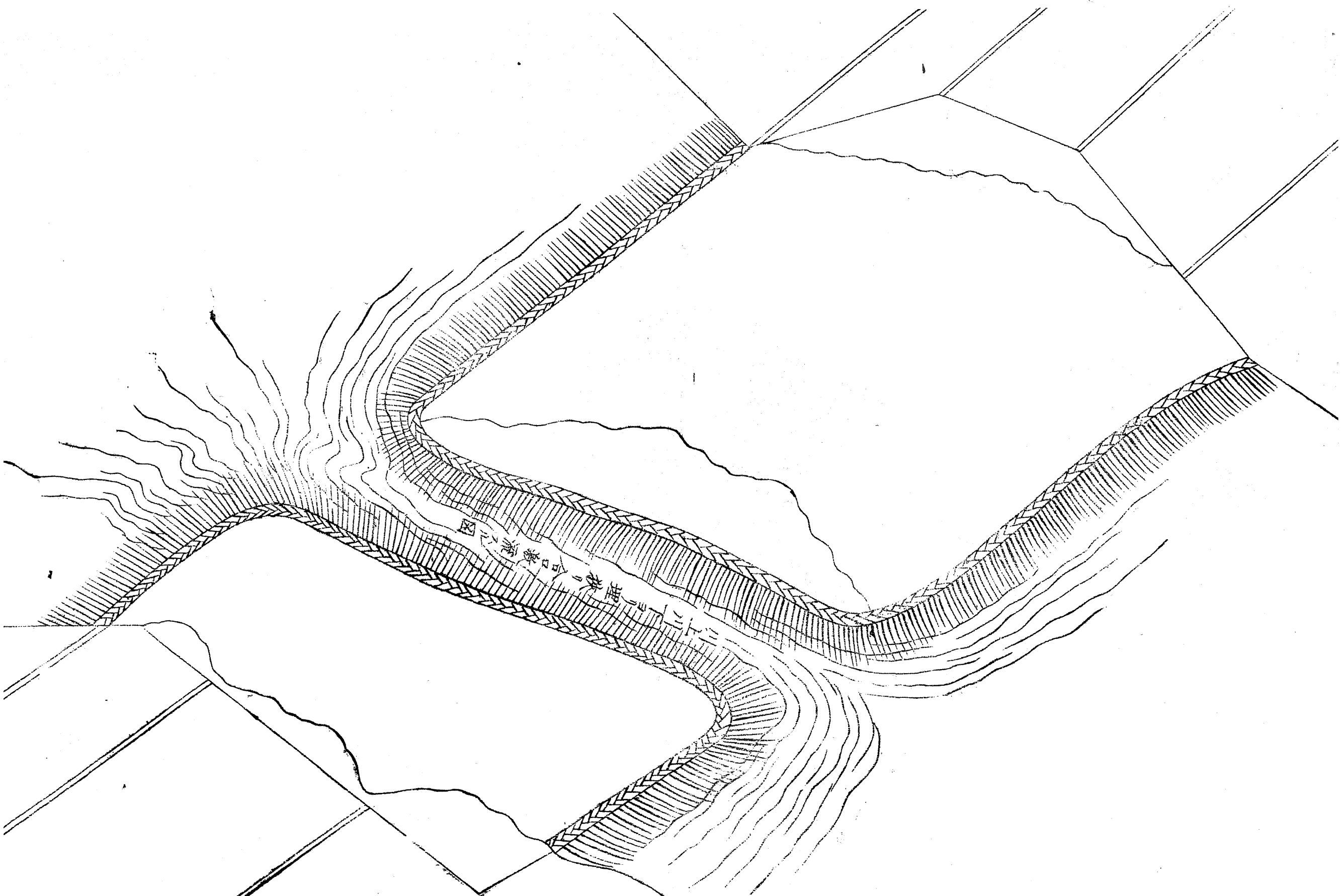

埋合口
埋合口
埋合口

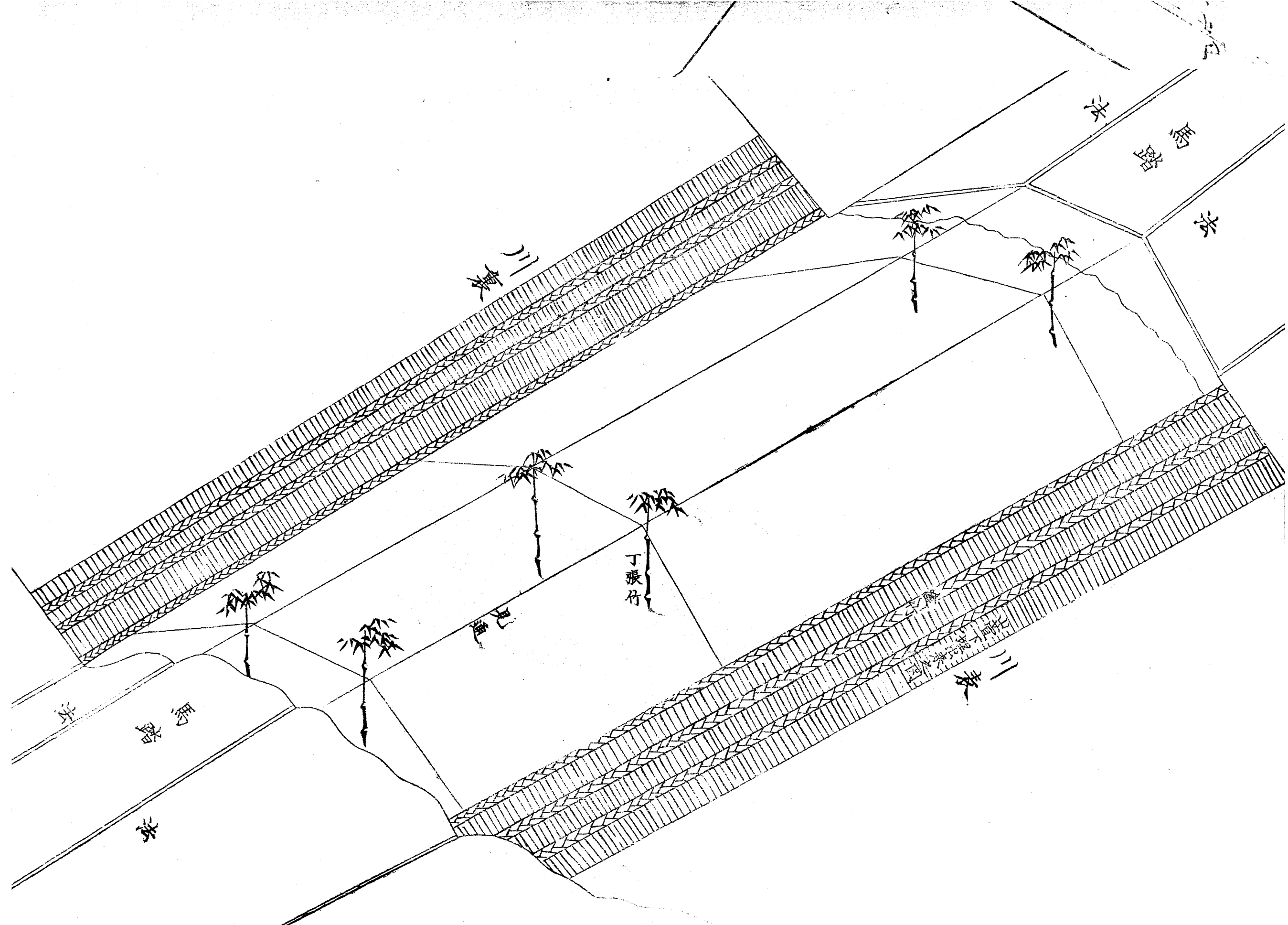

川

水

水

丁張竹

嶼

川

嶼

水

切所築立之圖

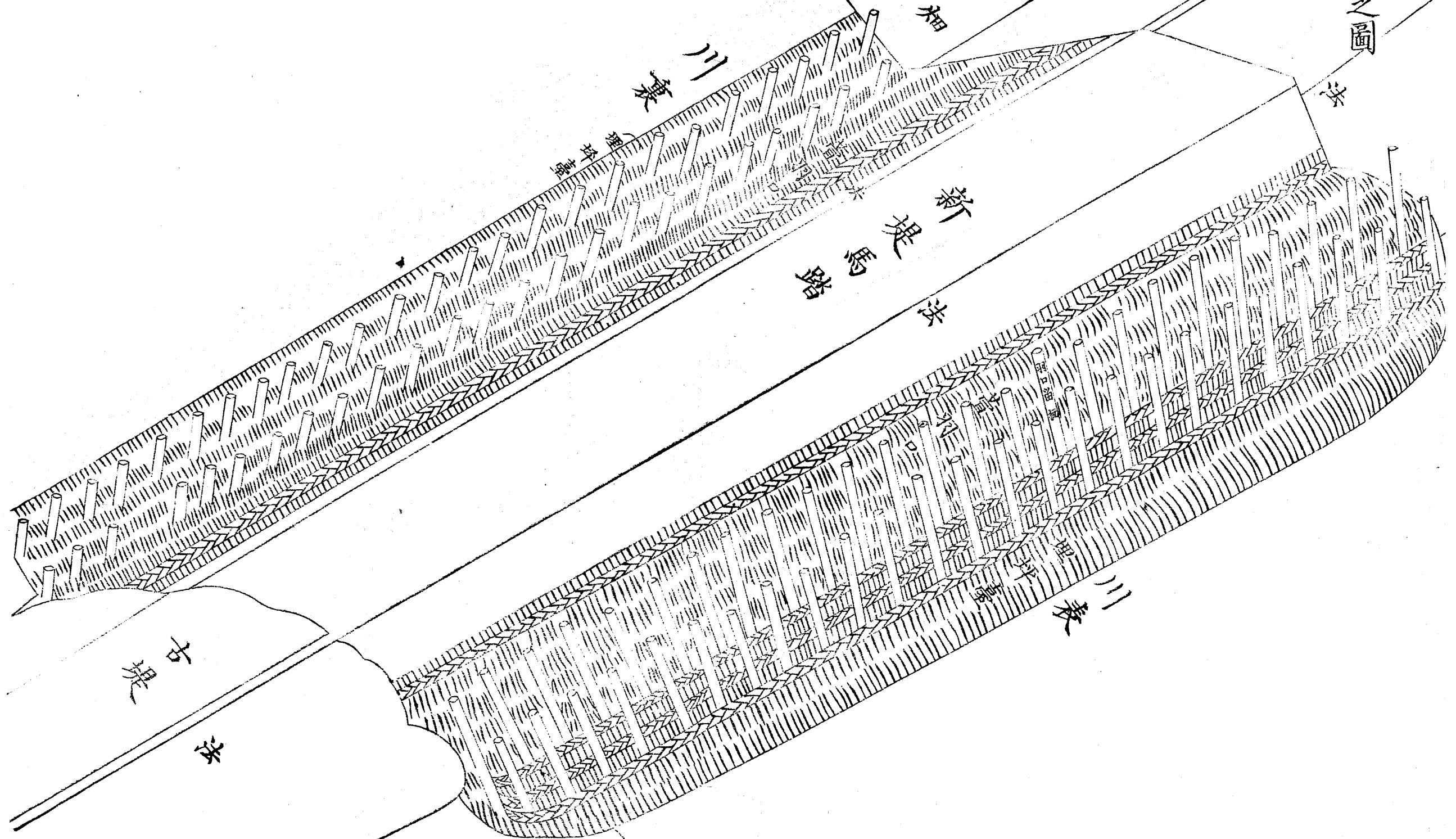

堤

堤

二層

第一層

堤

堤頂

堤

堤

簾采羽口
杭出
雜木掛並杭

之圖

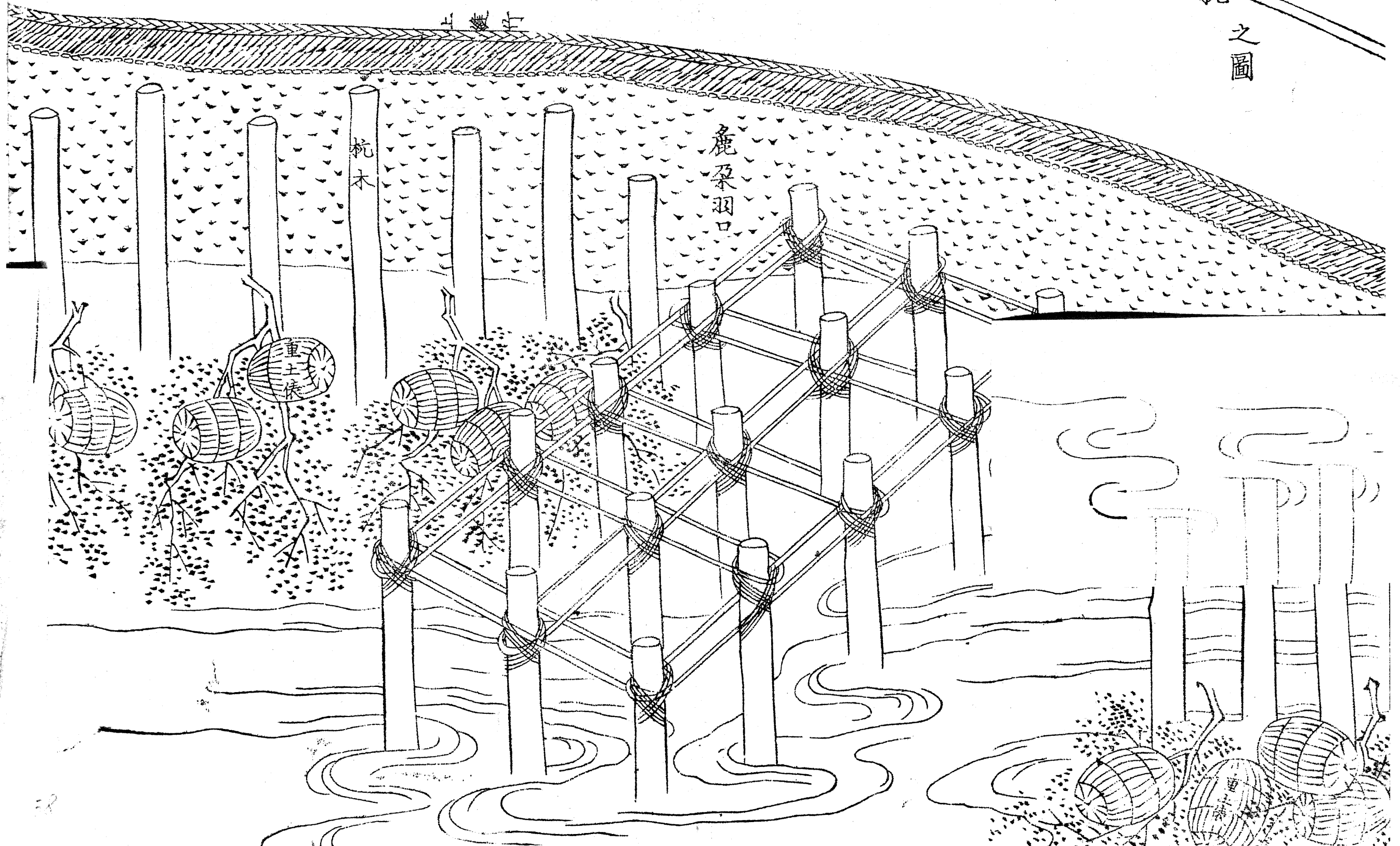

杭木

簾采羽口

兼采羽口
杭出
雜木掛並杭

之圖

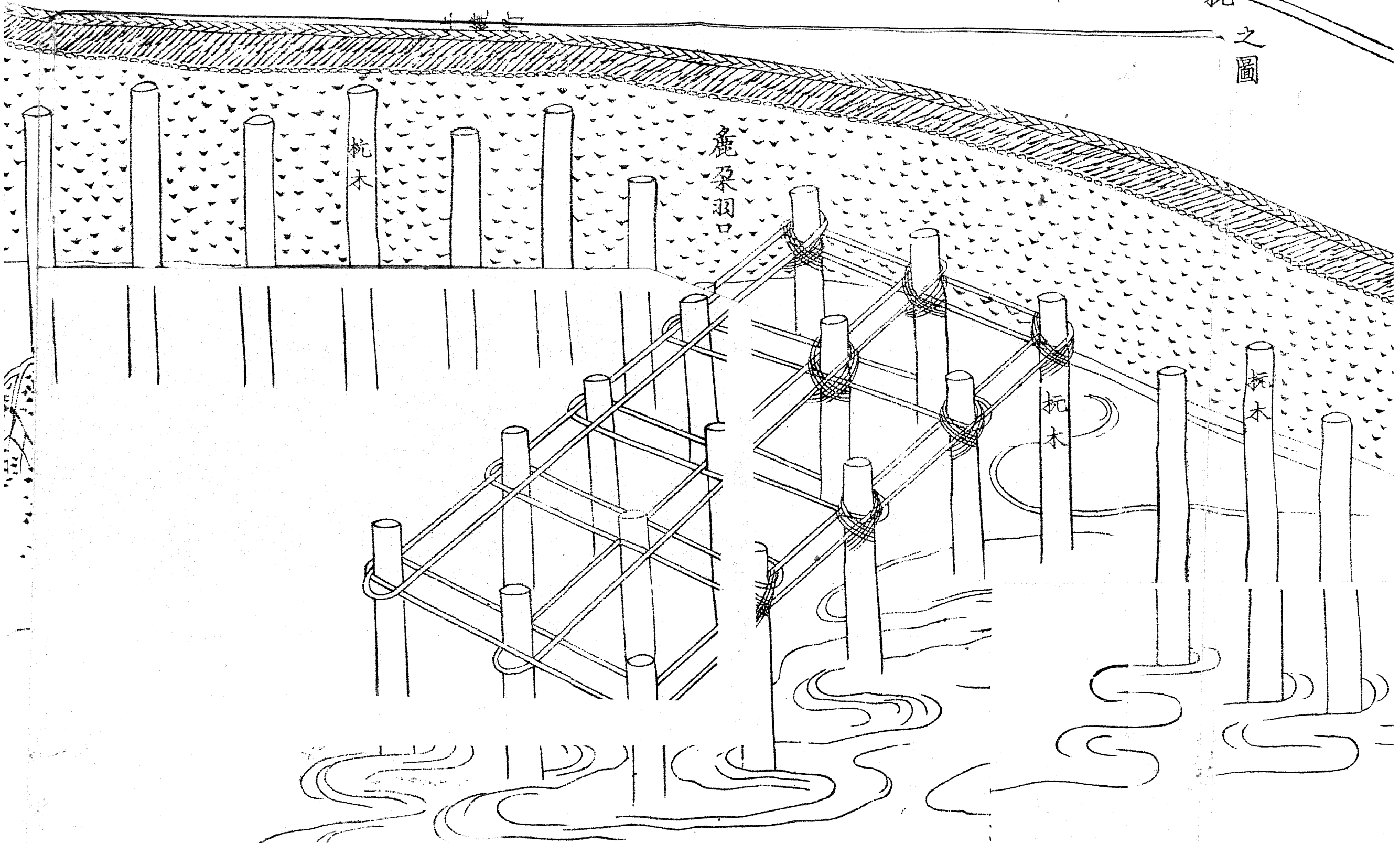

横笥之圖

土俵羽口之圖

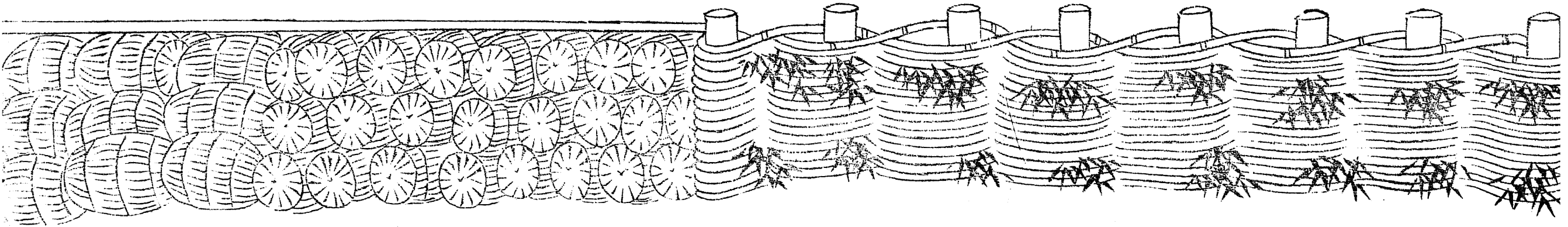

横土俵

竖土俵

布木結杭出之圖
立竹杭出

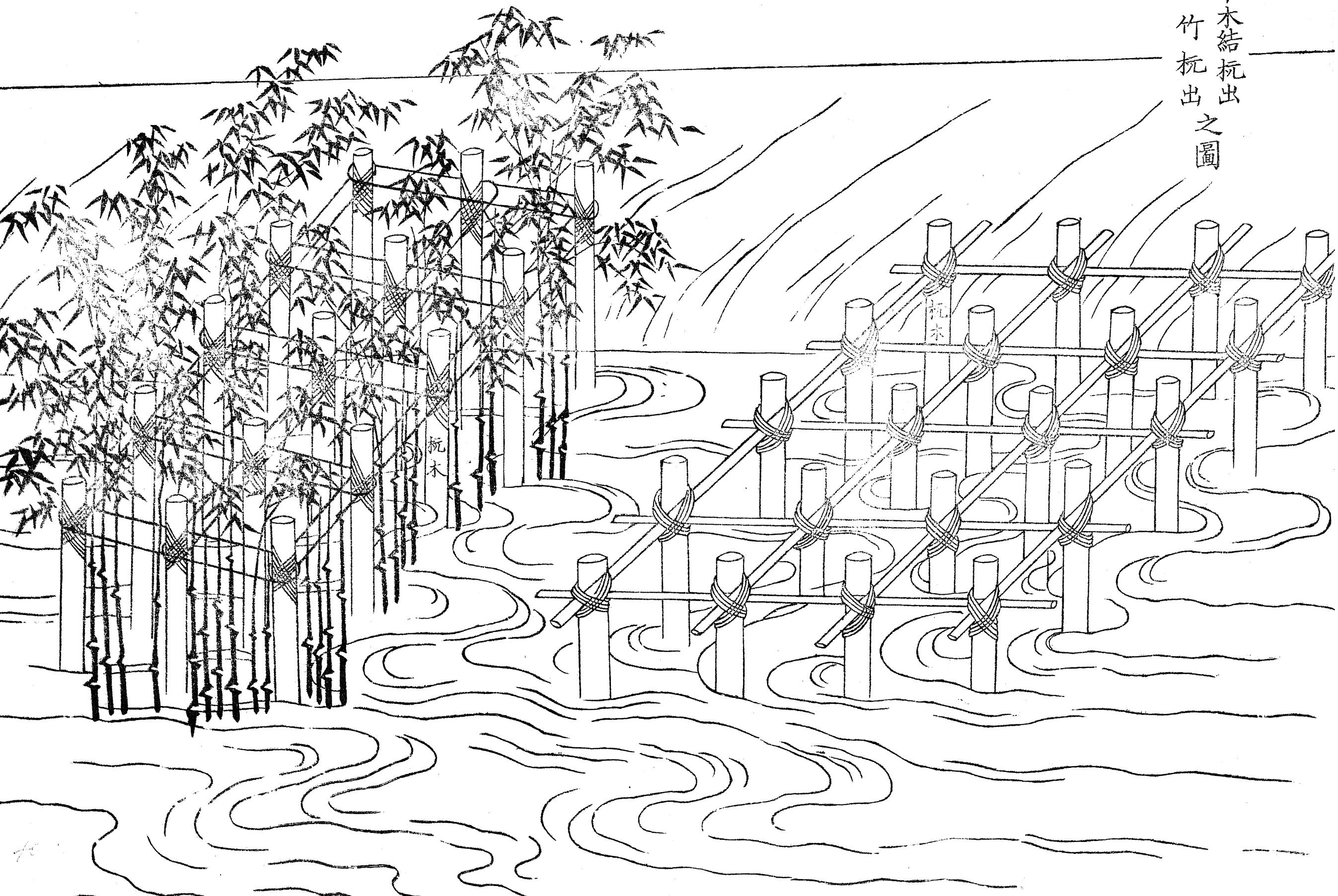

梁掛標出之圖

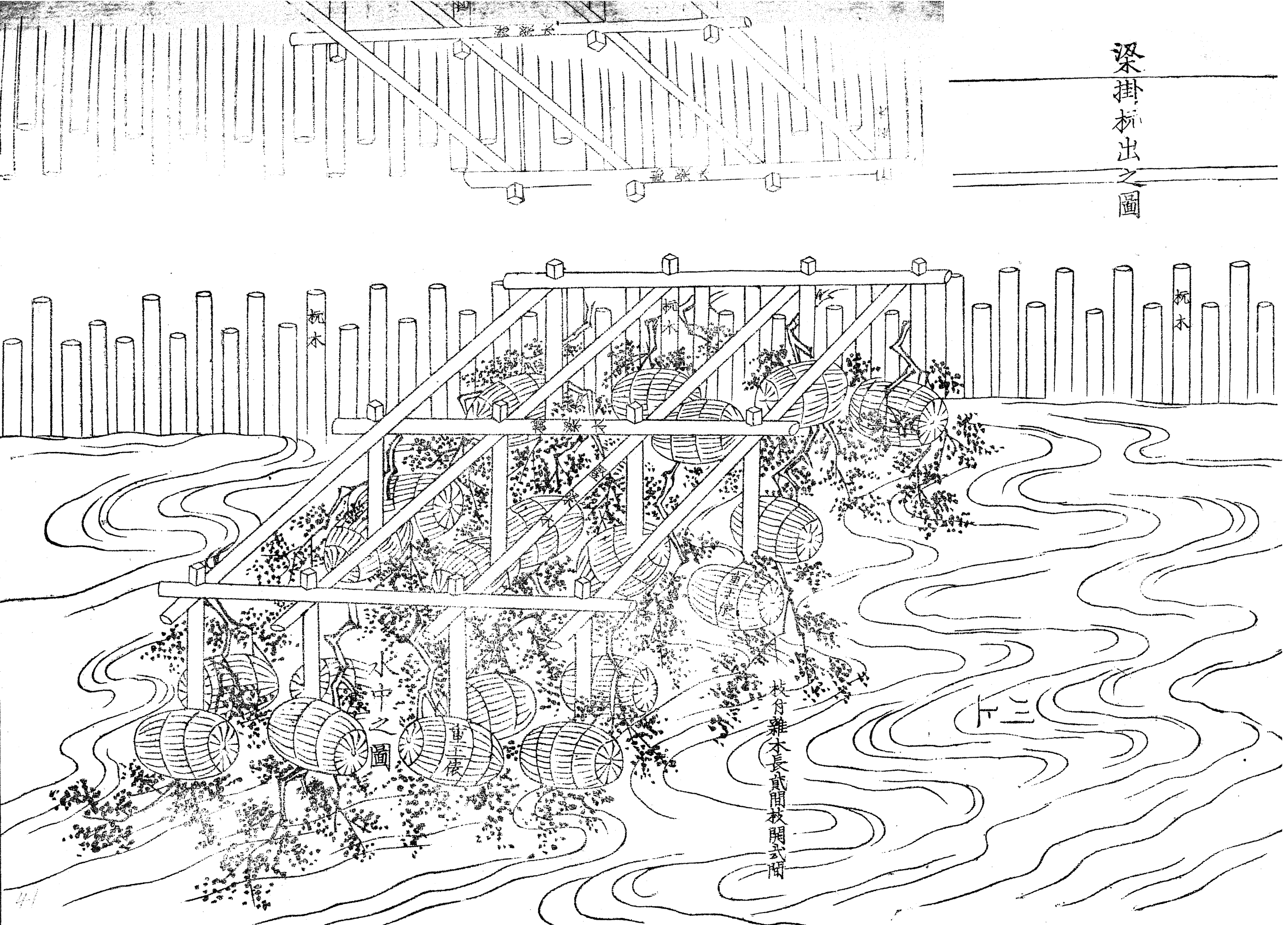

梁掛

梁掛

杭木

杭木

杭木

圖

舟上

枝舟雜木長貳間枝開式間

十三

梁掛標出之圖

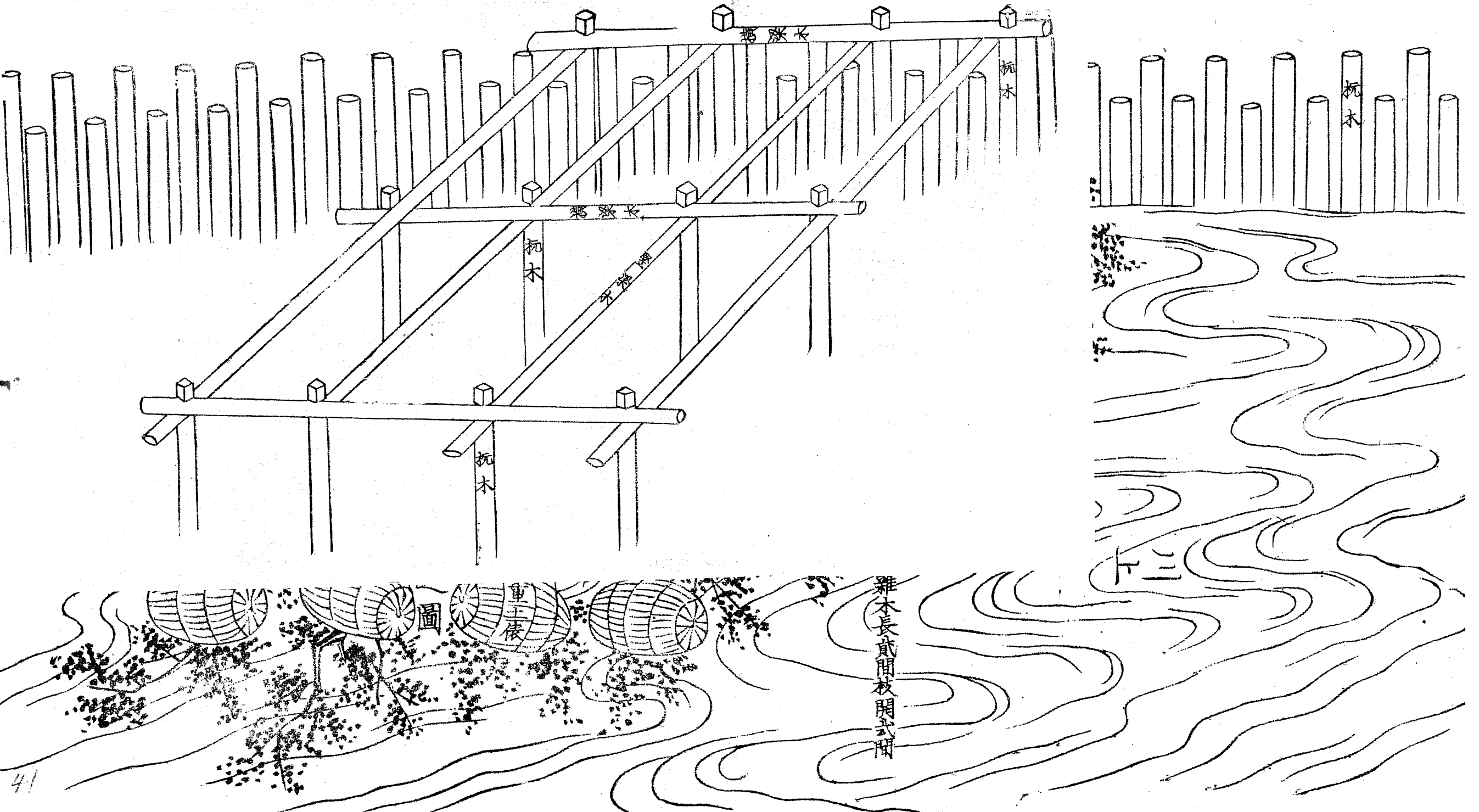

立竹並抗之圖

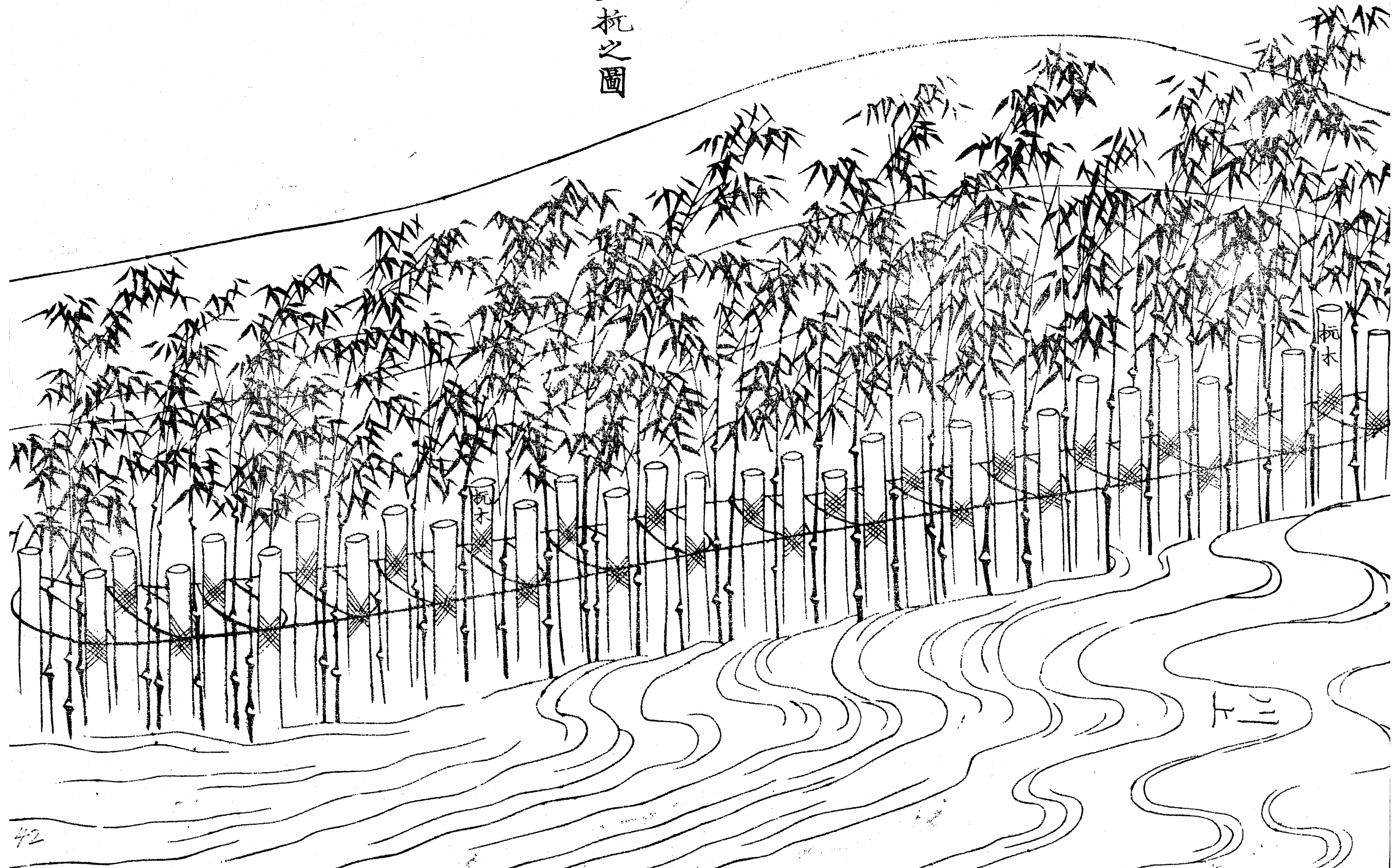

水分杭之圖

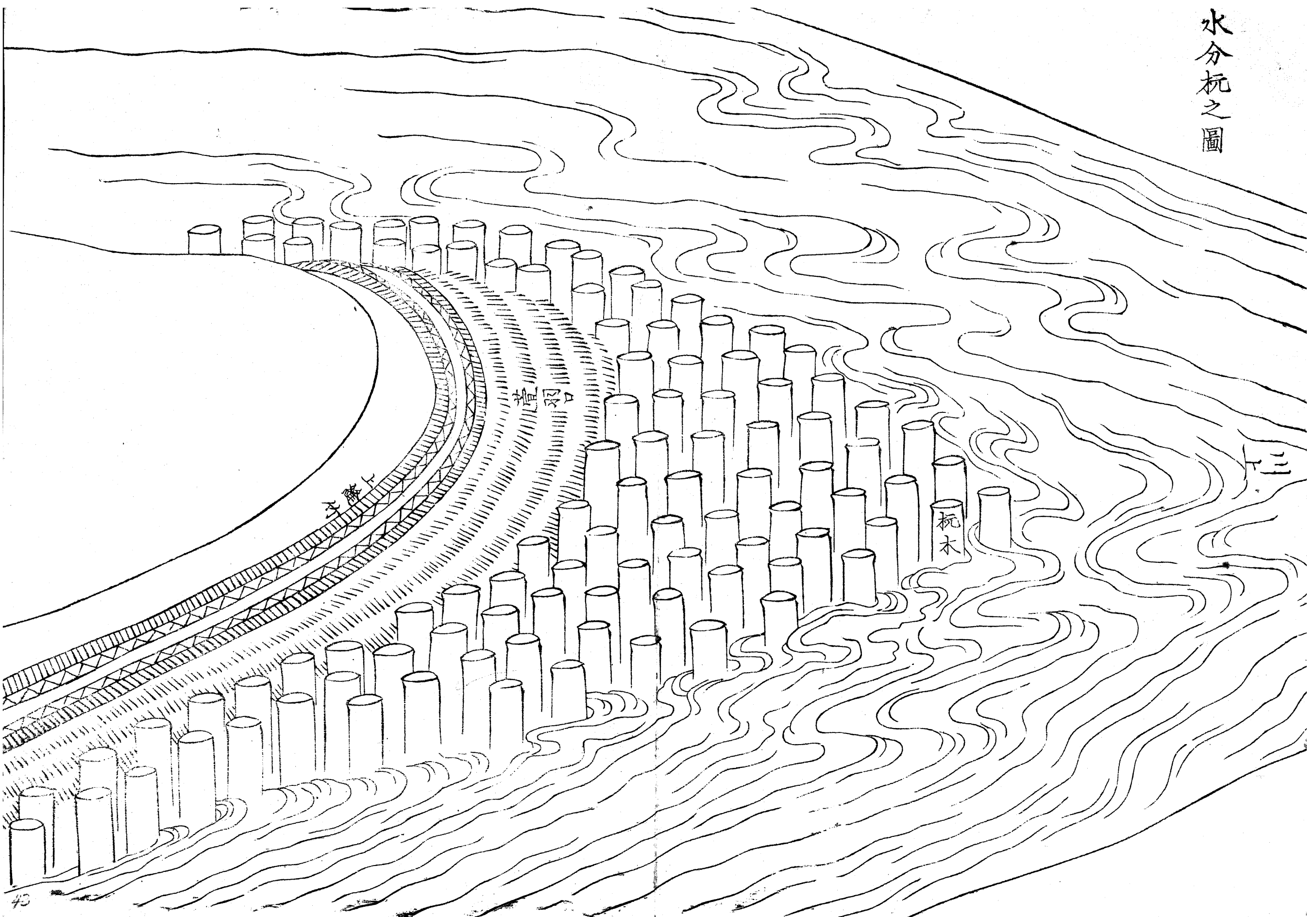

網代出之圖

